

Repair instructions

**ROTANTA 460 / 460 R
ROTANTA 460 S / 460 RS**



Andreas Hettich GmbH & Co. KG
Föhrenstraße 12, D-78532 Tuttlingen / Germany
Phone (07461) 705-0
Fax (07461) 705-125
info@hettichlab.com, service@hettichlab.com
www.hettichlab.com

© 2002 by Andreas Hettich GmbH & Co. KG

All rights reserved. No part of this publication may be reproduced without the written prior permission of the copyright owner.

Modifications reserved!

AR5600EN / 09.06

Contents

1	Introduction	6
2	Description of the centrifuge	6
2.1	Control panel (A4, A5)	6
2.2	Supply board (A1)	7
2.3	Frequency converter (A2)	8
2.4	Special features	9
2.5	Braking chopper (A3) / brake resistor (R1)	9
2.6	Motor / tacho system.....	9
2.7	Motor-driven lid lock.....	10
2.8	Imbalance switch	10
2.9	Key-operated switch (A7, optionally).....	10
2.10	Machine concept.....	10
2.11	Cooling system	11
2.11.1	Diagram of the cooling version.....	12
2.12	Ventilator control	13
2.13	Ventilator	13
2.14	Offset compensation	13
2.15	Safety devices.....	14
3	Troubleshooting procedures	14
4	Error messages	15
4.1	MAINS RESET	15
4.2	Brief description	15
4.3	Description and elimination of errors.....	18
5	Settings and interrogations	37
5.1	Option: program linkage (only for S-control panel)	37
5.1.1	Linking programs.....	37
5.1.2	Changing program links	37
5.1.3	Centrifugation run with program linking.....	38
5.1.4	Deleting program linking	38
5.2	Option: optical interface (only for S-control panel)	38
5.3	Option: key-operated switch (only for S-control panel)	39
5.4	Setting the lid lock mode.....	39
5.5	Setting the machine and cooling version	40
5.6	Function of the additional jumper	41
5.7	Initialization	41
5.7.1	Prerequisites for the initialization	41
5.7.2	Initializing the centrifuge with N-control panel.....	42
5.7.3	Initializing the centrifuge with S-control panel.....	43
5.8	OFFSET compensation	46
5.9	Imbalance Mode	48
5.9.1	Setting the imbalance mode on the supply board	48
5.9.2	Setting the imbalance mode in the program	48

5.10	Temp. Average Time	49
5.11	Leading time	50
5.12	Parameter for error message °C / *ERROR 58	51
5.12.1	Temperature monitor until reaching the temperature set value	51
5.12.1.1	Setting the temperature monitor with the N-control panel	52
5.12.1.2	Setting the temperature monitor with the S-control panel	52
5.12.2	Permissible temperature difference after reaching the temperature set value....	53
5.12.2.1	Setting the permissible temperature difference with the N-control panel ...	53
5.12.2.2	Setting the permissible temperature difference with the S-control panel	53
5.13	Parameter interrogation	54
5.13.1	Parameter interrogation N-control panel	54
5.13.2	Parameter interrogation S-control panel	54
5.14	Acoustic Signal	55
5.14.1	Acoustic Signal N-control panel	55
5.14.2	Acoustic signal S-control panel	55
5.15	Working hours	55
5.15.1	Working hours N-control panel.....	55
5.15.2	Working hours S-control panel.....	56
5.16	Checking the motor slippage	56
5.16.1	Checking the slippage with the N-control panel	56
5.16.2	Checking the slippage with the S-control panel	57
5.17	Checking the temperatures	57
5.17.1	Checking the temperatures with the N-control panel	57
5.17.2	Checking the temperatures with the S-control panel	58
5.18	Setting the date and time (only in S-control panel)	58
5.19	Centrifugation data displayed after switching on (only in S-control)	59
5.20	Immediate display of the centrifugation data after switching on (only in S-control panel).....	59
5.21	Logging (only in S-control panel)	59
5.21.1	Error messages.....	60
5.21.2	Imbalance messages	60
5.21.3	Modification logs	61
5.21.4	Note on the display of date and time.....	61
5.22	Setting the display contrast.....	61
5.23	Imbalance switch-off	63
6	Functional check after a repair	64
7	Mounting and removing components.....	64
7.1	Removing the front panel.....	64
7.2	Removing the support sheet of the electronic components	65
7.3	Removing the upper part of the centrifuge housing	65
7.4	Motor (M1)	66
7.5	Rubber-metal bearings	67
7.6	Vibration dampers.....	67
7.7	Speed sensor.....	67

7.8	Motor-driven lid lock.....	68
7.8.1	Removing the motor-driven lid lock.....	68
7.8.2	Replacing the motor-lock unit.....	69
7.8.3	Replacing the angle support on the left.....	69
7.8.4	Replacing the eccentric disc	70
7.8.5	Replacing the sliding blocks.....	70
7.8.6	Replacing the plastic rollers and discs	70
7.8.7	Replacing the microswitch	71
7.9	Control panel (A4, A5)	71
7.9.1	N-control panel (A4).....	71
7.9.2	S-control panel (A5)	71
7.10	EPROM in the control panel	71
7.11	Battery (only in S-control panel).....	71
7.12	Supply board (A1)	72
7.13	Frequency converter (A2)	72
7.14	Braking chopper (A3).....	73
7.15	Radio interference suppression filter (Z1).....	73
7.16	Brake resistor (R1).....	73
7.17	Temperature sensors (only in centrifuges with cooling).....	73
7.17.1	Temperature sensor at the top of the centrifuge chamber (T1)	73
7.17.2	Temperature sensor at the bottom of the centrifuge chamber (T2)	74
7.17.3	Temperature sensor on the condenser (T3)	74
7.18	Imbalance switch (S2).....	74
7.19	Mains switch	75
7.20	Appliance plug with overvoltage protection.....	75
7.21	Gas spring.....	75
7.22	Sealing ring (between the upper part of the centrifuge housing and the lid).....	76
7.23	Key-operated switch (A7; only in S-control panel)	76
7.24	Optical interface (A6; only in S-control panel).....	77
8	Designation of the components	79
9	Technical documents.....	82
9.1	Tachometer code configuration of the rotors	82
9.1.1	Centrifuge without cooling.....	82
9.1.2	Centrifuge with cooling.....	83
9.2	Cooling diagram.....	84
9.3	Connecting diagrams	85
9.3.1	Abbreviations of the cable colours	85
9.3.2	Connecting diagram centrifuge	86
9.3.3	Transformer connection	88
9.3.3.1	Centrifuge without cooling system.....	88
9.3.3.2	Centrifuge with cooling system.....	88
9.4	Technical specifications	89

1 Introduction

- Repairs must only be carried out by personnel authorised to do so by the manufacturer.



Interventions and modifications at centrifuges, which have been conducted by persons not authorized by the HETTICH company, are at their own risk and entail the loss of all guarantee and liability claims. In such an event any guarantee claim or liability claim against the HETTICH company expires.

- Only original spare parts and original accessories licensed by the Hettich company are allowed to be utilised.



If no original spare parts or no original accessories are used, any guarantee claim or liability claim against the HETTICH company ceases to exist.

- Information about the operation of the centrifuge please see operating instructions.
- We reserve all rights for these technical documents.

2 Description of the centrifuge

These microprocessor controlled centrifuges mainly consist of the following electrical components:

- Control panel, microprocessor controlled
 - N-control panel, (without control knob)
 - S-control panel, (with control knob)
- Supply board, microprocessor controlled
 - for centrifuges with cooling
 - for centrifuges without cooling
- Frequency converter (motor control), microprocessor controlled
- Motor with speed sensor (speedometer) and imbalance switch
- Braking chopper with brake resistor
- Lid lock

2.1 Control panel (A4, A5)

The control panel is the brain or the master of the centrifuge. This MASTER controls its SLAVES via a serial data bus system. These SLAVES are the following components:

- supply board
- frequency converter

The control panel carries out the following tasks:

- Managing operator entries and controlling the LCD display
- Saving run programs:
 - N-control panel: 3 programs
 - S-control panel: 89 programs
- Controlling the components:
 - supply board via the serial interface
 - frequency converter via the release line and the serial interface
- Evaluating the speed sensor (speedometer)
- Evaluating the imbalance switch

- Evaluating the frequency converter error message line
- Evaluating the message line lid lock open/closed
- Triggering the relay for the voltage supply of the lid lock when the rotor has standstill
- Temperature measurement and evaluation of the temperature sensor at the top of the centrifuge chamber
- Routine for input, saving and transmitting temperature offset values (offset values are transmitted to the supply board each time the mains supply is switched on)
- Type of serial interface:
 - N-control panel:
5 Volt interface with three wires (16-pole flat ribbon cable, pole 6, 8 and 11)
 - S-control panel:
RS 485 interface via two wires (26-pole flat ribbon cable, pole 19 and 20)
- The voltage supply for the control panel is provided by the supply board via the flat ribbon cable:
 - N-control panel: + 15...20 Volt: pole 1, 2 and GND: pole 15, 16
 - S-control panel: + 15...20 Volt: pole 1, 2, 25, 26 and GND: pole 15, 16, 17, 18

2.2 Supply board (A1)

The supply board carries out the following tasks:

- Current supply 18 V DC and 5 V DC for the supply board
- Current supply 18 V DC for the control panel
- Temperature measurement and evaluation of the temperature sensor at the bottom of the centrifuge chamber
- Evaluating the overtemperature switch in the centrifuge chamber
- Temperature measurement and evaluation of the temperature sensor on the condenser
- Evaluating the overpressure switch (not in ROTANTA 460 series)
- Evaluating the message line lid lock open/closed
- Evaluating the overtemperature switch on the brake resistor (when the overtemperature switch opens, the frequency converter will be switched off)
- Voltage supply for the speed sensor (speedometer)
- Slot for speed sensor cable and transmission of the speed pulses to the control panel
- Evaluating the speedometer pulses with regard to standstill
- Triggering the relay for the voltage supply of the lid lock when the rotor has standstill
- Slot for imbalance switch and direct transmission of the imbalance signal to the control panel
- Processing the individual sensor temperatures:
 - calculating the ACTUAL temperature
 - controlling the cooling units
 - controlling the heating
 - controlling the solenoid valve
 - controlling the condenser ventilator

- SLAVE behaviour (the requests and commands of the control panel are transmitted via the serial interface):
 - N-control panel:
5 Volt interface with three wires
 - S-control panel:
RS 485 interface with two wires
- The 5 Volt interface with three wires is transferred to a RS 485 interface with two wires.
Interface for the frequency converter: RS 485 interface via two wires
- Transmitting the main enable signal control panel ⇒ frequency converter
- Transmitting the error line frequency converter ⇒ control panel
- Evaluating the switching statuses of the key-operated switch (e.g. LOCK 1) and transmitting the information to the control panel via the serial interface (only with centrifuge with key-operated switch)
- Evaluating the jumper assignment and transmitting the information to the control panel via the serial interface
 - Machine version
 - Cooling version
 - Service mode

If the processor of the supply board detects an error, it switches off automatically. The control panel continuously checks the status of the supply board via the serial interface.

The control panel defines the SET temperature and OFFSET temperatures via the serial interface. The control panel inquires the ACTUAL temperature.

2.3 Frequency converter (A2)

The frequency converter carries out the following tasks:

- Generating the motor current supply
(three-phase current with variable frequency and voltage)
Functional description: The supply voltage is rectified, smoothed and chopped into a pulse width pattern in three bridge elements with a microprocessor.
- Monitoring the motor current
- Evaluating the overtemperature switch in the motor
- SLAVE behaviour (the requests and commands of the control panel are transmitted via the serial interface):
RS 485 Volt interface with two wires
(5-pole flat ribbon cable, pole 2 and 3)
- Evaluating the main enable signal for the frequency converter
(5-pole flat ribbon cable, pole 1)
- Evaluating possible errors and handling the error line
(5-pole flat ribbon cable, pole 4)
- The following are defined by the control panel via the serial interface:
 - Speed
 - Starting and brake levels
 - Control commands START, BRAKE, STOP

- LED status displays:
In the standby status the red LED illuminates
In the run status the green LED illuminates
In the error status the red LED flashes

If the frequency converter processor detects an error, it switches off automatically and sets the error line. Then the control panel inquires the type of error via the serial interface.

2.4 Special features

- The voltage supply of the motor-driven lock is switched via a relay on the supply board.
This relay can pick up only if the control panel and the supply board have detected a standstill.
- The N-control panel and the S-control panel are interchangeable.
- Multiprocessor concept:
If a processor stops working, the other two processors still continue monitoring their area.
If there is a control panel failure, the frequency converter automatically switches off the drive if no inquiries are made via the interface for longer than 60 seconds.
- Interface concept:
The information transmission is monitored with an additional check sum.
- Hardware concept:
All safety related switches are break contacts. This also ensures that loose contacts and cable rupture can be detected.

2.5 Braking chopper (A3) / brake resistor (R1)

- The braking chopper transfers the electrical energy produced during braking, from a voltage of approx. 390 Volt, to the brake resistor in a controlled manner.
- An overtemperature switch protects the brake resistor against fire. If the braking chopper has a short circuit, the brake resistor becomes hot due to the high current, the overtemperature switch opens the circuit and two relays on the supply board separate the frequency converter from the mains supply.

2.6 Motor / tacho system

- The motor is a three-phase asynchronous motor with four pairs of poles.
- A speed sensor (speedometer) which is screwed onto the motor receives
 - the rotor code information and
 - the speed information (6 pulses per revolution)from the magnets of the tacho ring attached to the rotor.
- The control panel monitors and regulates the ACTUAL speed.
 - Double safety: In addition, the frequency converter has been programmed in such a way that it is not possible to set a speed value which is higher than the permissible rotor speed.
- The control panel and the supply board monitor the rotor standstill.
 - Double safety: The lid can be opened only when the control panel and the supply board have detected a standstill.

2.7 Motor-driven lid lock

- The lid can be opened only if the motor of the lid lock is triggered. To do so, press the  key when the rotor is not moving and mains voltage exists. The jumper for the lid lock must be plugged to the position "Mot" on the supply board.
- The motor locks the lid only if both lid brackets have actuated both switches in the lid lock.
- You can start the centrifuge only if the lid is closed. A microswitch on the lid lock detects the lid lock position.

2.8 Imbalance switch

- A switch (break contact) detects imbalance.
- Imbalance is detected only in running mode (starting, centrifuging and braking).
- If imbalance is detected, the drive is brought to a standstill.

2.9 Key-operated switch (A7, optionally)

- With the key-operated switch different program locks can be select, see chapter "Option: key-operated switch (only for S-control panel)". The key position will be displayed.
- If the key is removed, the selected program lock is locked and can be changed no more.

2.10 Machine concept

- The machine version is set with jumper assignment A.4, A.5 and B.7 on the coding strip of the supply board, see chapter "Setting the machine and cooling version".
- This machine version must comply with the control panel:
 - N-control panel: correct EPROM
 - S-control panel: correct initialization
- This machine version must comply with the installed and initialized frequency converter.
- The machine version has a binary code:

Version	Machine	Jumper / Value		
		A.4	A.5	B.7
		1	2	16
19	ROTANTA 460 230 V / 115 V	X	X	X

2.11 Cooling system

- The cooling version is set with jumper assignment A.0 to A.2 on the coding strip of the supply board, see chapter "Setting the machine and cooling version".
- This cooling version must comply with the control panel:
 - N-control panel: correct EPROM
 - S-control panel: correct initialization
- The cooling version has a binary code:

Version	Cooling System	Jumper / Value		
		A.0	A.1	A.2
		1	2	4
0	No cooling system			
1	1 compressor	X		
2	1 compressor, heating/cooling		X	
7	No cooling system, laboratory thermostat	X	X	X

- Hardware control:
 - If the lid is opened, the cooling or heating system switches off.
 - If the overtemperature switch is opened, the heating system switches off.
- Software control:
 - If the condenser temperature is higher than 58°C, the cooling system switches off.
 - The processor on the supply board controls the cooling system.
 - The control panel sets the nominal temperature and the temperature of the temperature sensor T1 on the supply board via the serial interface.
 - The control panel inquires the ACTUAL temperature via the serial interface.
 - Temperature sensor:

T1 Temperature sensor at the top of the centrifuge chamber

This temperature is processed in the control panel.

T2 Temperature sensor at the bottom of the centrifuge chamber

This temperature is processed on the supply board.

The T2 temperature sensor housing also includes an overtemperature switch.

It switches off the drive in cooling centrifuges when the temperature is > 60°C and in heating/cooling centrifuges if it is > 80°C.

Temperature determination:

During centrifugation the temperature is determined on the basis of the relationship between T1 and T2. This occurs in different ways depending on the speed range (see chapter "Diagram of the cooling version, sensor evaluation"). During standstill, the temperature is determined only with the T2 temperature sensor.

The switching temperatures depend on the cooling version, see chapter "Diagram of the cooling version"

T3 Temperature sensor on the condenser

This temperature is used for controlling the ventilator speed.

2.11.1 Diagram of the cooling version

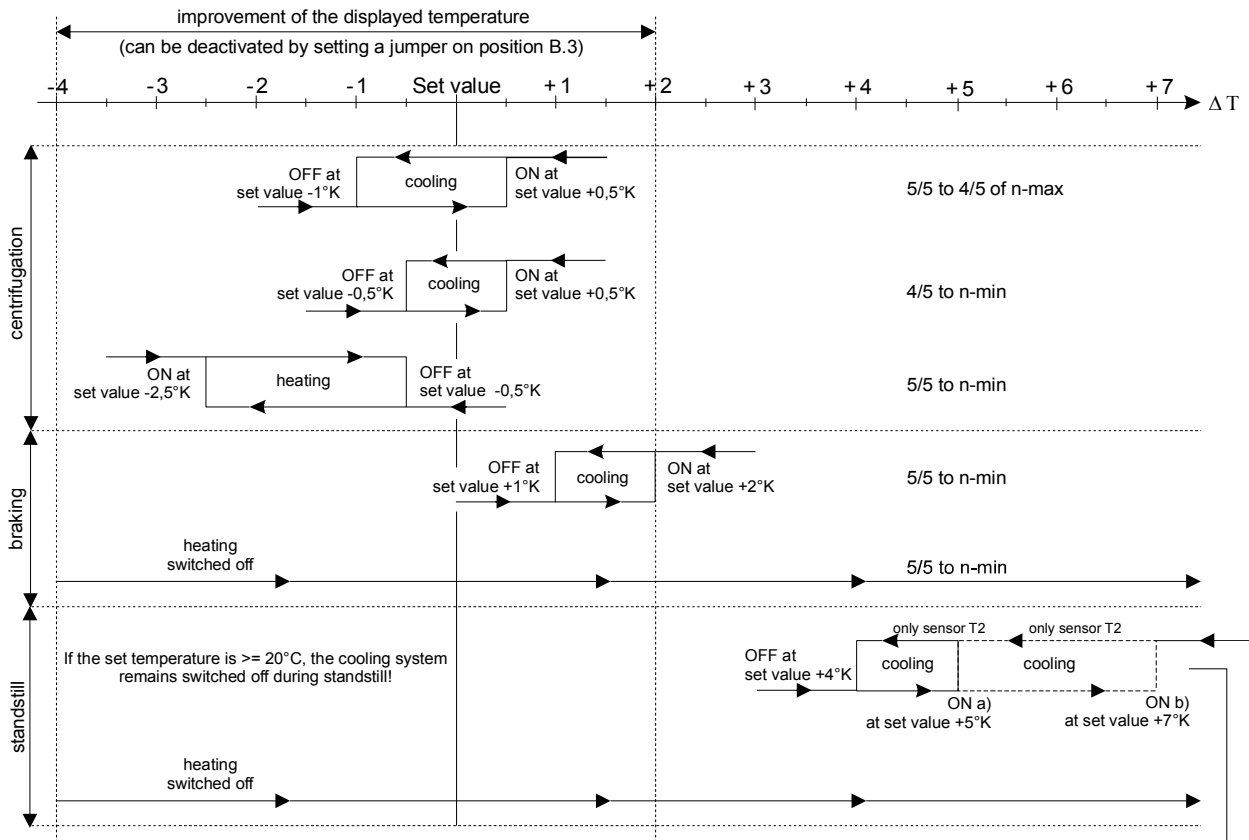

sensor evaluation

	temperature sensor T1	temperature sensor T2
speed range 5/5 to 4/5 of n-max rotor	1	1
speed range 4/5 to 3/5 of n-max rotor	2	1
speed range 3/5 to 2/5 of n-max rotor	3	1
speed range 2/5 to 1/5 of n-max rotor	4	1
speed range 1/5 to n-min	5	1

T1 : temperature sensor at the top of the centrifuge chamber
 T2 : temperature sensor at the bottom of the centrifuge chamber

Explanation on: ON a) = cycle time 60 s ON / 6 min OFF
 ON b) = cycle time 90 s ON / 6 min OFF

The cooling will only be switched on 15 s after start

2.12 Ventilator control

- The ventilator control is a temperature-dependent phase control.
- If the cooling system switches on, the ventilator runs with a fixed start speed.
- When the condenser temperature rises, the ventilator runs faster.
- At 32 °C, or at the latest after 60 seconds, the ventilator speed regulation is activated and the ventilator speed is regulated to achieve a constant temperature of 34°C at the condenser.
- If the cooling system is switched off and the condenser temperature falls, the ventilator speed is reduced until minimum speed is achieved.
- If the temperature is lower than 28 °C, the phase control is not triggered, the ventilator comes to a standstill.

Centrifuge type	Start speed	Maximum speed	Minimum speed
ROTANTA 460 R / RS 230 V / 50 Hz	approx. 2000 RPM	approx. 2700 RPM	approx. 900 RPM
ROTANTA 460 R / RS 230 V / 60 Hz	approx. 1900 RPM	approx. 2950 RPM	approx. 820 RPM

- The ventilator runs in a temperature-controlled manner also if the lid is open.
- If there is condenser overtemperature (overpressure in the system) i.e. temperature sensor T3 indicates a temperature > 58 °C (3.31 V), the cooling system and the drive are switched off, but the condenser ventilator continues running.

2.13 Ventilator

- The ventilator cools down the refrigerant which flows through the condenser.
- The ventilator speed is controlled with the temperature sensor T3.
- This speed control keeps the pressure in the cooling system constant as far as possible.

2.14 Offset compensation

- The offset compensation is carried out to balance the tolerances of the temperature sensors and the electronic system.

After replacing:	Offset compensation:
– a temperature sensor	Compensation of the concerned temperature sensor.
– the supply board	Compensation of the temperature sensors T2 and T3.
– the control panel	Compensation of the temperature sensor T1 and read out the old offset values of T2 and T3 and enter them in the new control panel.
– the control panel EPROM	Compensation is not required

2.15 Safety devices

Mains input	⇒ overvoltage protection
Mains switch	⇒ with thermal overload protection
Radio interference suppression filter	⇒ between supply board and frequency converter
Frequency converter	⇒ electronically protected
Motor	⇒ overtemperature switch > 135 °C
Cooling system	⇒ overtemperature switch in the centrifuge chamber, software monitoring of the temperature sensor T3 on the condenser
PE connection	⇒ additional earthing of the device (only with 115 V model)

3 Troubleshooting procedures

- Fuses in installation in which centrifuge is installed are intact.
- Supply voltage present at (see circuit diagram):
 - Connecting cable
 - Appliance plug
 - Overvoltage protection (F4)
 - Mains switch (Q1)
 - Supply board, plugs X21 and X29.
- Look for the displayed error code in the chapter "Error messages".
- Remedy the error according to the instructions.
- Carry out a functional check after every repair and whenever a component is replaced, see chapter "Functional check after a repair".

4 Error messages

4.1 MAINS RESET

- Switch off the mains switch.
- Wait for 10 seconds and then switch on the mains switch again.

4.2 Brief description

Error designation	No.	Brief description	Page
TACHO-ERROR	01	Speedometer pulses break down during rotation	18
TACHO-ERROR	02	No speedometer pulses after start command	18
IMBALANCE	(03)	Imbalance on motor axle	19
CONTROL-ERROR	04	Lid lock error, lid opened without recognizing that motor had stopped	19
N > MAX	05	Excessive speed error, 250 RPM above n-max of rotor	19
CONTROL-ERROR	06	Lid lock - error Message: from control panel → lid lock open from supply board → lid lock closed	20
CONTROL-ERROR	07	Lid lock - error Message: from control panel → lid lock closed from supply board → lid lock open	20
CONTROL-ERROR	08	Standstill error Message: from control panel → standstill from supply board → no standstill	20
CONTROL-ERROR	09	Standstill error Message: from control panel → no standstill from supply board → standstill	20
ROTORCODE	10	Invalid rotor code	21
MAINS INTERRUPT	(11)	Mains interruption	21
VERSION-ERROR	12	Error in initialization	21
N < MIN	13	Speed error, slippage is too great	22

Error designation	No.	Brief description	Page
CONTROL-ERROR	21	N-control panel - error: speed	22
CONTROL-ERROR	22	N-control panel - error: I ² C-bus	22
CONTROL-ERROR	23	N-control panel - error: display memory	22
CONTROL-ERROR	24	N-control panel - error: clock timeout	22
CONTROL-ERROR	25	N-control panel - error: EEPROM	22
CONTROL-ERROR	27	N-control panel - error: EPROM defective	23
N > ROTOR-MAX	---	N-control panel - error: nominal speed is higher than permitted rotor speed or nominal RCF is higher than permitted rotor RCF	23
CONTROL-ERROR	26	Incorrect feedback, control panel input do not recognize the expected signal	22
SER I/O-ERROR	30	No connection between control panel and serial interface	23
SER I/O-ERROR	31	No connection between frequency converter and serial interface	23
SER I/O-ERROR	32	No connection between supply board and serial interface	24
SER I/O-ERROR	33	Data incorrectly transmitted from the componentry	24
SER I/O-ERROR	34	Data incorrectly transmitted between control panel and frequency converter	24
SER I/O-ERROR	35	Data incorrectly transmitted between control panel and supply board	24
SER I/O-ERROR	36	No acknowledgement (NAK) from frequency converter to control panel	25
SER I/O-ERROR	37	No acknowledgement(NAK) from supply board to control panel	25
°C / *-ERROR	50	Overpressure in cooling system	25
°C / *-ERROR	51	Overtemperature on condenser	26
°C / *-ERROR	52	Overtemperature in centrifuge chamber	26
°C / *-ERROR	53	Temperature sensor at the bottom of the centrifuge chamber is defective	27
°C / *-ERROR	54	Temperature sensor at the top of the centrifuge chamber is defective	27
°C / *-ERROR	55	Temperature sensor on the condenser is defective	28
LOCK-ERROR	57	Program locking is defective	28
°C / *-ERROR	58	Temperature deviation too high	29

Error designation	No.	Brief description	Page
FU/CCI-ERROR	60	Faulty release signal to frequency converter	29
FU/CCI-ERROR	61	Frequency converter - error: computing section	30
FU/CCI-ERROR	62	Frequency converter - error: undervoltage	30
FU/CCI-ERROR	63	Frequency converter - error: overcurrent	30
FU/CCI-ERROR	64	Frequency converter - error: overvoltage	31
FU/CCI-ERROR	65	Frequency converter - error: I * t switch-off for motor	31
FU/CCI-ERROR	66	Frequency converter - error: I * t switch-off of frequency converter	31
FU/CCI-ERROR	67	Frequency converter - error: overtemperature in motor (external)	32
FU/CCI-ERROR	68	Frequency converter - error: overtemperature in frequency converter	32
FU/CCI-ERROR	69	Frequency converter - error: EEPROM	33
CONTROL-ERROR	90	S-control panel - error: EPROM	33
CONTROL-ERROR	91	S-control panel - error: RAM	33
CONTROL-ERROR	92	S-control panel - error: difference between EEPROM and RAM	34
CONTROL-ERROR	94	S-control panel - error: Watchdog	34
CONTROL-ERROR	95	S-control panel - error: inadmissible operative state	34
N > ROTOR - MAX	96	S-control panel - error: nominal speed is higher than permitted rotor speed or nominal RCF is higher than permitted rotor RCF	35
CONTROL-ERROR	97	S-control panel - error: EEPROM	35
CONTROL-ERROR	99	S-control panel - error: hardware failure in error management	35
INDEFINITE		S-control panel - error: not specified error	36
BATT		Battery is empty	36

4.3 Description and elimination of errors

TACHO - ERROR 01

Error	During centrifugation the speedometer pulses are interrupted.
Consequences of the error	The rotor slows down until it stops. After the rotor stops, there is a DC braking for 30 sec. A MAINS RESET during slowing-down causes a DC braking for 3 minutes. After the DC braking, the “open the lid” release takes place. Further cooling until the SET temperature is achieved.
Cause of error/measurements	<ul style="list-style-type: none"> • Speed sensor (speedometer) is defective or loose contact in the plug. Measure the speedometer pulses on the supply board (A1) at plug X5, pin 4 - pin 2. • Flat ribbon cable to the control panel (A4, A5) or flat ribbon cable to the frequency converter (A2) is defective. • Supply board (A1) or control panel (A4, A5) or frequency converter (A2) is defective.
Delete error code	Open the lid. Turn the rotor by hand and carry out a MAINS RESET while the rotor is rotating. <ul style="list-style-type: none"> – In the S-control panel, CONTROL - ERROR 08 could appear in the display after TACHO - ERROR 01 is deleted.

TACHO - ERROR 02

Error	After starting the centrifugation the control panel receives no speedometer pulses.
Consequences of the error	The rotor slows down until it stops. After the rotor stops, there is a DC braking for 30 sec. A MAINS RESET during slowing-down causes a DC braking for 3 min. After the DC braking, the “open the lid” release takes place. Further cooling until the SET temperature is achieved.
Cause of error/measurements	<ul style="list-style-type: none"> • Start implemented without rotor • Motor is not connected • Motor is defective • Speed sensor (speedometer) is defective or loose contact in the plug. Measure the speedometer pulses on the supply board (A1) at plug X5, pin 4 - pin 2. • Flat ribbon cable to the control panel (A4, A5) or flat ribbon cable to the frequency converter (A2) is defective. • No enable signal at the frequency converter (A2) (after a start, the green LED on the frequency converter must illuminate), also refer to FU / CCI – ERROR 60. • Supply board (A1) or control panel (A4, A5) or frequency converter (A2) is defective.
Delete error code	Open the lid. Turn the rotor by hand and carry out a MAINS RESET while the rotor is rotating.

IMBALANCE (03)

Error	Imbalance on the motor axle.
Consequences of the error	The centrifuge slows down until the “open the lid” release occurs. Further cooling until the SET temperature is achieved.
Cause of error	<ul style="list-style-type: none"> • Weight difference in the rotor components • Supporting lugs are not lubricated • Wrong IMBALANCE MODE has been set (see chapter "Imbalance Mode") • Imbalance switch (S2) is not connected • Imbalance switch (S2) is defective • Loose contact in the cable or in the plug • Flat ribbon cable to the control panel (A4, A5) is defective • Control panel (A4, A5) or supply board (A1) is defective
Delete error code	Open the lid or carry out a MAINS RESET.

CONTROL - ERROR 04

Error	Lid lock was opened during centrifugation.
Consequences of the error	The centrifuge slows down until the “open the lid” release occurs. Further cooling until the SET temperature is achieved.
Cause of error	<ul style="list-style-type: none"> • Lid lock (Y1) is defective and can be opened during centrifugation. • Loose contact in the cable or in the plug • Flat ribbon cable to the control panel (A4, A5) is defective • Control panel (A4, A5) or supply board (A1) is defective
Delete error code	Open the lid and close it again or carry out a MAINS RESET. In the S-control panel, CONTROL – ERROR 06 or CONTROL – ERROR 08 could appear in the display after CONTROL – ERROR 04 is deleted.

N > MAX 05

Error	Overspeed. The speed detected by the speed sensor is 250 RPM higher than the maximum rotor speed (n-max rotor).
Consequences of the error	The centrifuge slows down until the “open the lid” release occurs. Further cooling until the SET temperature is achieved.
Cause of error	<ul style="list-style-type: none"> • The insulation of the speed sensor cable is defective • Loose contact in the speed sensor cable • Speed sensor is defective • Flat ribbon cable to the control panel (A4, A5) is defective • Control panel (A4, A5) or frequency converter (A2) or supply board (A1) is defective
Delete error code	Carry out a MAINS RESET.

CONTROL - ERROR 06

Error Lid lock message is faulty.
Control panel indicates: lid lock open
Supply board indicates: lid lock closed

Consequences of the error The centrifuge slows down until the “open the lid” release occurs.
Further cooling until the SET temperature is achieved.

Cause of error

- Flat ribbon cable to the control panel (A4, A5) is defective
- Control panel (A4, A5) or supply board (A1) is defective

Delete error code Carry out a MAINS RESET.

CONTROL - ERROR 07

Error Lid lock message is faulty.
Control panel indicates: lid lock closed
Supply board indicates: lid lock open

Consequences of the error The centrifuge slows down until the “open the lid” release occurs.
Cooling system is switched off.

Cause of error

- Flat ribbon cable to the control panel (A4, A5) is defective
- Supply board (A1) or control panel (A4, A5) is defective

Delete error code Carry out a MAINS RESET.

CONTROL - ERROR 08

Error Standstill message is faulty.
Control panel indicates: standstill
Supply board indicates: no standstill

Consequences of the error Braked slow-down.
Further cooling until the SET temperature is achieved.

Cause of error

- Flat ribbon cable to the control panel (A4, A5) is defective
- Control panel (A4, A5) or supply board (A1) is defective

Delete error code Carry out a MAINS RESET.

CONTROL - ERROR 09

Error Standstill message is faulty.
Control panel indicates: no standstill
Supply board indicates: standstill

Consequences of the error Braked slow-down.
Further cooling until the SET temperature is achieved.

Cause of error

- Flat ribbon cable to the control panel (A4, A5) is defective
- Control panel (A4, A5) or supply board (A1) is defective

Delete error code Carry out a MAINS RESET.

ROTORCODE 10

Error	An invalid rotor code was read in during start-up.
Consequences of the error	The centrifuge slows down until the “open the lid” release occurs. Further cooling until the SET temperature is achieved.
Cause of error	<ul style="list-style-type: none">• Magnetic code on the rotor is defective• Speedometer system is defective• Loose contact in speed sensor plug• Motor is rotating in the wrong direction
Delete error code	Open the lid or carry out a MAINS RESET.

MAINS INTERRUPT (11)

Error	Mains interruption during centrifugation
Consequences of the error	The centrifuge slows down until the “open the lid” release occurs. – Switching on the mains during centrifugation causes slowing-down until the “open the lid” release occurs. – Switching on the mains when the rotor has stopped brings about the “open the lid” release
Cause of error	<ul style="list-style-type: none">• Power failure• Loose contact in the electrical connections• Flat ribbon cable to the control panel (A4, A5) is defective
Delete error code	Open the lid and press the START key – The error <u>cannot</u> be deleted with a MAINS RESET.

VERSION - ERROR 12

Error	Differences in the initialization of supply board (jumper assignment A.0 – A.7, B.7), control panel (EPROM) or frequency converter. – In the S-control panel, VERSION – ERROR 12 also appears after CONTROL – ERROR 92 is displayed
Consequences of the error	Further operation is not possible.
Cause of error	<ul style="list-style-type: none">• Incorrect jumper assignment (A.0 – A.7 and B.7) on the coding strip of the supply board Plug the jumper A.0 – A.7 and B.7 as described in chapter "Setting the machine and cooling version".• Carry out a MAINS RESET.• Plug the service jumper at B.1 on the supply board, carry out a MAINS RESET and re-initialize the machine• A wrong EPROM is plugged in the control panel• Supply board (A1) is defective
Delete error code	Carry out a MAINS RESET.

N < MIN 13

Error Insufficient speed, motor slippage is too large.
The centrifuge control can readjust the speed by max. 5 % (control limit).
This error is displayed if the rotor speed (ACTUAL speed) is lower than the SET speed - 5%.

Consequences of the error The centrifuge slows down until the “open the lid” release occurs.
Further cooling until the SET temperature is achieved.

Cause of error

- Motor is not running smoothly (bearing damage)
- Motor is defective
- Motor has a short-circuited coil (coil is defective)
- Loose contact in the electrical connections
- Frequency converter (A2) is defective
- Enable signal to the frequency converter (A2) was interrupted during centrifugation (also see **FU / CCI - ERROR 60**).

Delete error code Open the lid and carry out a MAINS RESET.

CONTROL - ERROR 21 - 25

Error Internal error in the N-control panel

Consequences of the error The centrifuge slows down until the “open the lid” release occurs.

Cause of error

- N-control panel (A4) is defective.

Delete error code Carry out a MAINS RESET.

CONTROL - ERROR 26

Error Incorrect feedback, control panel input does not recognize the expected signal.

Consequences of the error The centrifuge stops with error message.

Cause of error

- Control panel (A4, A5) is defective.
- Supply board (A1) is defective
- Flat ribbon cable between supply board (A1) and control panel (A4, A5) is defective.

Delete error code Carry out a MAINS RESET.

CONTROL - ERROR 27

Error	Error in the EPROM of the N-control panel
Consequences of the error	The centrifuge slows down until the "open the lid" release occurs.
Cause of error	<ul style="list-style-type: none">• EPROM is defective
Delete error code	Carry out a MAINS RESET.

N > ROTOR-MAX

Error	Error in the entered program
Consequences of the error	Further operation is not possible.
Cause of error	SET speed or SET RCF is higher than the permissible rotor speed or permissible rotor RCF.
Delete error code	Open the lid. Reduce the speed or RCF in the entered program to the permissible rotor speed or permissible rotor RCF.

SER I/O - ERROR 30

Error	The control panel has no connection to the components supply board and frequency converter via serial interface.
Consequences of the error	The centrifuge slows down until the "open the lid" release occurs.
Cause of error	<ul style="list-style-type: none">• Flat ribbon cable to the control panel (A4, A5) is defective• Supply board (A1) or control panel (A4, A5) is defective
Delete error code	Carry out a MAINS RESET.

SER I/O - ERROR 31

Error	The control panel has no connection to the component frequency converter via the serial interface.
Consequences of the error	The centrifuge slows down until the "open the lid" release occurs. Further cooling until the SET temperature is achieved.
Cause of error	<ul style="list-style-type: none">• Flat ribbon cable to the frequency converter (A2) is defective• No voltage at the frequency converter (A2)• Overtemperature switch (F2) on the brake resistor has opened or is not connected• Supply board (A1) or control panel (A4, A5) or frequency converter (A2) is defective.• Plug X5 on the frequency converter (A2) is not plugged or plugged at the wrong position
Delete error code	Carry out a MAINS RESET.

SER I/O - ERROR 32

Error The control panel has no connection to the component supply board via the serial interface.

Consequences of the error The centrifuge slows down until the “open the lid” release occurs.

Cause of error

- The false machine or cooling version is set on the supply board (A1).
- Supply board (A1) or control panel (A4, A5) is defective.

Delete error code Carry out a MAINS RESET.

SER I/O - ERROR 33

Error The control panel does not receive correct data from the connected components (supply board, frequency converter).

Consequences of the error The centrifuge slows down until the “open the lid” release occurs.

Cause of error

- Flat ribbon cable to the control panel (A4, A5) is defective
- Supply board (A1) or control panel (A4, A5) or frequency converter (A2) is defective.

Delete error code Carry out a MAINS RESET.

SER I/O - ERROR 34

Error The control panel does not receive correct data from the frequency converter.

Consequences of the error The centrifuge slows down until the “open the lid” release occurs. Further cooling until the SET temperature is achieved.

Cause of error

- Flat ribbon cable to the control panel (A4, A5) is defective
- Flat ribbon cable to the frequency converter (A2) is defective
- Supply board (A1) or control panel (A4, A5) or frequency converter (A2) is defective.

Delete error code Carry out a MAINS RESET.

SER I/O - ERROR 35

Error The control panel does not receive correct data from the supply board.

Consequences of the error The centrifuge slows down until the “open the lid” release occurs.

Cause of error

- Flat ribbon cable to the control panel (A4, A5) is defective
- Supply board (A1) or control panel (A4, A5) is defective

Delete error code Carry out a MAINS RESET.

SER I/O - ERROR 36

Error	The frequency converter cannot acknowledge a command and sends the NAK signal to the control panel. NAK (no acknowledge).
Consequences of the error	The centrifuge slows down until the “open the lid” release occurs. Further cooling until the SET temperature is achieved.
Cause of error	<ul style="list-style-type: none">• Flat ribbon cable to the control panel (A4, A5) is defective• Flat ribbon cable to the frequency converter (A2) is defective• Frequency converter (A2) is defective• Supply board (A1) or control panel (A4, A5) is defective
Delete error code	Carry out a MAINS RESET.

SER I/O - ERROR 37

Error	The supply board cannot acknowledge a command and sends the NAK signal to the control panel. NAK (no acknowledge)
Consequences of the error	The centrifuge slows down until the “open the lid” release occurs.
Cause of error	<ul style="list-style-type: none">• Flat ribbon cable to the control panel (A4, A5) is defective• Supply board (A1) is defective• Control panel (A4, A5) or frequency converter (A2) is defective
Delete error code	Carry out a MAINS RESET.

°C / * - ERROR 50

Error	Overpressure in the cooling system (only in centrifuges with an overpressure switch on the plug X11) No overpressure switch has been integrated in the ROTANTA 460 series. On the supply board, pin 2 and pin 3 on plug X11 are connected with each other.
Consequences of the error	The centrifuge slows down until the “open the lid” release occurs. Cooling system is switched off.
Cause of error	Plug X11 on the supply board (A1) is not plugged or has a loose contact.
Delete error code	Carry out a MAINS RESET.

°C / * - ERROR 51

Error	Overtemperature in the condenser, temperature > 58 °C.
Consequences of the error	The centrifuge slows down until the “open the lid” release occurs. Cooling system is switched off.
Cause of error/measurements	<ul style="list-style-type: none">• Measurement on the supply board (A1) at plug X1, pin 1 - pin 2 (plug X1 plugged) Voltage at 25 °C : 2.98 V (± 20 mV) at 58 °C : 3.31 V (± 20 mV)• Condenser is dirty• Ventilator is defective• Cable of the temperature sensor on the capacitor (T3) is defective• Loose contact in the plug• Supply board (A1) is defective
Delete error code	Carry out a MAINS RESET.

°C / * - ERROR 52

Error	Overtemperature in the centrifuge chamber
Consequences of the error	The centrifuge slows down until the “open the lid” release occurs. Cooling system is switched off.
Cause of error/measurements	<ul style="list-style-type: none">• Measurement on the supply board (A1) at plug X2, pin 1 - pin 2 (plug X2 plugged) Voltage : 0 V (overtemperature switch closed) Voltage : 18 V (overtemperature switch open)• Cable of the overtemperature switch is defective• Loose contact in the plug• Supply board (A1) is defective
Delete error code	Carry out a MAINS RESET.

°C / * - ERROR 53

Error	The temperature sensor at the bottom of the centrifuge chamber has a short circuit or has opened the circuit. Voltage < 0.50 V = short circuit Voltage > 4.50 V = circuit has been opened
Consequences of the error	The centrifuge slows down until the “open the lid” release occurs. Cooling system is switched off.
Cause of error/measurements	<ul style="list-style-type: none">• Measurement on the supply board (A1) at plug X2, pin 4 - pin 5 (plug X2 plugged) Voltage at 25 °C : 2.98 V (± 20 mV) A temperature change of 1 °K causes a voltage change of 10 mV.• Temperature sensor at the bottom of the centrifuge chamber (T2) is defective• Sensor cable is defective• Loose contact in the plug• Supply board (A1) is defective
Delete error code	Carry out a MAINS RESET.

°C / * - ERROR 54

Error	The temperature sensor at the top of the centrifuge chamber has a short circuit or has opened the circuit. Permissible range: 2.50 V = -23 °C to 3.77 V = +104 °C
Consequences of the error	The centrifuge slows down until the “open the lid” release occurs. Cooling system is switched off.
Cause of error/measurements	<ul style="list-style-type: none">• Measurement on the control panel (A4, A5) at plug X100 or X2, pin 1 - pin 2 (plug X100 or X2 plugged) Voltage at 25 °C : 2.98 V (± 20 mV) A temperature change of 1 °K causes a voltage change of 10 mV.• Temperature sensor at the top of the centrifuge chamber (T1) is defective• Sensor cable is defective• Loose contact in the plug• Control panel (A4, A5) is defective
Delete error code	Carry out a MAINS RESET.

°C / * - ERROR 55

Error	The temperature sensor on the condenser has a short circuit or has opened the circuit. Voltage < 0.50 V = short circuit Voltage > 4.50 V = circuit has been opened
Consequences of the error	The centrifuge slows down until the “open the lid” release occurs. Cooling system is switched off.
Cause of error/measurements	<ul style="list-style-type: none"> • Measurement on the supply board (A1) at plug X1, pin 1 - pin 2 (plug X1 plugged) Voltage at 25 °C : 2.98 V (± 20 mV) A temperature change of 1 °K causes a voltage change of 10 mV. • Temperature sensor on the capacitor (T3) is defective • Sensor cable is defective • Loose contact in the plug • Supply board (A1) is defective
Delete error code	Carry out a MAINS RESET.

LOCK - ERROR 57

Error	The analogous value in the program locking plug X27 indicates that the voltage is outside the voltage range. Permissible voltage range: 0.9 V - 3.8 V.
Consequences of the error	Further operation is not possible.
Cause of error/measurements	<ul style="list-style-type: none"> • Measurement on the supply board at plug X27, pin 1 - pin 2 (plug X27 plugged) Key-operated switch position 1 (LOCK1) ≈ 1.4 V 2 (LOCK2) ≈ 2.1 V 3 ≈ 3.3 V • Key-operated switch board is defective • Cable to the key-operated switch board is defective • Loose contact in the wire layout • Supply board (A1) is defective
Delete error code	Carry out a MAINS RESET.

°C / * - ERROR 58

Error	Temperature deviation too high.
Consequences of the error	The centrifuge slows down until the "open the lid" release occurs. Cooling system is switched off.
Cause of error	<ul style="list-style-type: none">• Temperature range is set too low (see chapter "Parameter for error message °C / *ERROR 58").• Failure in the cooling system.• Supply board (A1) is defective.
Delete error code	Carry out a MAINS RESET.

FU / CCI - ERROR 60

Error	The enable signal was not transmitted correctly to the frequency converter. The enable signal is evaluated only once after a MAINS RESET.
Consequences of the error	Further operation is not possible.
Cause of error/ measurements	<ul style="list-style-type: none">• Measurement on the supply board (A1) at plug X7, pin 1 - pin 5 (plug X7 plugged)<ul style="list-style-type: none">Lid is not locked: 0 VLid is locked, after start: 15 V - 20 V, typical 18 V• Flat ribbon cable to the frequency converter (A2) is defective• Flat ribbon cable to the control panel (A4, A5) is defective• Supply board (A1) is defective
Delete error code	Carry out a MAINS RESET.

General notes for FU / CCI - ERROR 61 to FU / CCI - ERROR 69

The microprocessor of the frequency converter independently manages the errors which have occurred. If there is an error, the red LED on the frequency converter starts flashing. The information is sent to the control panel via the flat ribbon cables from the frequency converter to the supply board and from the supply board to the control panel. If the control panel issues an error message and the LED of the frequency converter does not flash, then

- the flat ribbon cable from the frequency converter to the supply board is defective,
- the flat ribbon cable from the supply board to the control panel is defective,
- the supply board is defective.
- Measurement on the supply board (A1) at plug X7, pin 4 - pin 5 (plug X7 on the supply board (A1) and plug X5 on the frequency converter (A2) plugged)
 - No error: 0 V
 - Error: 5 V

FU / CCI - ERROR 61

Error	Error in the computing section.
Consequences of the error	The frequency converter switches off automatically. The rotor slows down unbraked. Further operation is not possible. Further cooling occurs until the set value is achieved.
Cause of error	<ul style="list-style-type: none">• Also see General notes for FU / CCI - ERROR 61 to FU / CCI - ERROR 69• Flat ribbon cable is defective• Supply board (A1) or frequency converter (A2) is defective.
Delete error code	Carry out a MAINS RESET. Mains switch ON after 2 minutes.

FU / CCI - ERROR 62

Error	Supply voltage lower than 205 V AC
Consequences of the error	The frequency converter switches off automatically. The rotor slows down unbraked. Further operation is not possible. Further cooling occurs until the set value is achieved.
Cause of error	<ul style="list-style-type: none">• Also see General notes for FU / CCI - ERROR 61 to FU / CCI - ERROR 69• Supply voltage is too low• Flat ribbon cable is defective• Supply board (A1) or frequency converter (A2) is defective.
Delete error code	Carry out a MAINS RESET. Mains switch ON after 2 minutes.

FU / CCI - ERROR 63

Error	Overcurrent
Consequences of the error	The frequency converter switches off automatically. The rotor slows down unbraked. Further operation is not possible. Further cooling occurs until the set value is achieved.
Cause of error	<ul style="list-style-type: none">• Also see General notes for FU / CCI - ERROR 61 to FU / CCI - ERROR 69• Short circuit in the motor• Motor impedance is too low• Flat ribbon cable is defective• Supply board (A1) or frequency converter (A2) is defective.
Delete error code	Carry out a MAINS RESET. Mains switch ON after 2 minutes.

FU / CCI - ERROR 64

Error	Overvoltage (voltage in the intermediate circuit > 410 V DC). Normally this error occurs only when the drive is being braked.
Consequences of the error	The frequency converter switches off automatically. The rotor slows down unbraked. Further operation is not possible. Further cooling occurs until the set value is achieved.
Cause of error	<ul style="list-style-type: none">• Also see General notes for FU / CCI - ERROR 61 to FU / CCI - ERROR 69• Braking chopper (A3) is defective• Flat ribbon cable is defective• Supply board (A1) or frequency converter (A2) is defective.
Delete error code	Carry out a MAINS RESET. Mains switch ON after 2 minutes.

FU / CCI - ERROR 65

Error	$I * t$ - switch off for the motor. The motor current was too high for a long period.
Consequences of the error	The frequency converter switches off automatically. The rotor slows down unbraked. Further operation is not possible. Further cooling occurs until the set value is achieved.
Cause of error	<ul style="list-style-type: none">• Also see General notes for FU / CCI - ERROR 61 to FU / CCI - ERROR 69• Motor impedance is too low The individual winding resistances are too low.• Flat ribbon cable is defective• Supply board (A1) or frequency converter (A2) is defective.
Delete error code	Carry out a MAINS RESET. Mains switch ON after 2 minutes.

FU / CCI - ERROR 66

Error	$I * t$ - switch off of frequency converter.
Consequences of the error	The frequency converter switches off automatically. The rotor slows down unbraked. Further operation is not possible. Further cooling occurs until the set value is achieved.
Cause of error	<ul style="list-style-type: none">• Also see General notes for FU / CCI - ERROR 61 to FU / CCI - ERROR 69• Flat ribbon cable is defective• Supply board (A1) or frequency converter (A2) is defective.
Delete error code	Carry out a MAINS RESET. Mains switch ON after 2 minutes.

FU / CCI - ERROR 67

Error	Overtemperature in the motor The message wire "Overtemperature in the motor" is highly impedance.
Consequences of the error	The frequency converter switches off automatically. The rotor slows down unbraked. Further operation is not possible. Further cooling occurs until the set value is achieved.
Cause of error/ measurements	<ul style="list-style-type: none"> • Also see General notes for FU / CCI - ERROR 61 to FU / CCI - ERROR 69 • The overtemperature switch in the motor opens due to high motor temperature. It can take up to 10 minutes to reset the overtemperature switch. • Plug X4 on the frequency converter (A2) is not plugged or has a loose contact (voltage at the frequency converter (A2) plug X4 = 16 V DC)
<div style="border: 1px solid black; padding: 5px; display: inline-block;">  <p>Be extremely careful while taking measurements as there may be mains voltage.</p> </div>	
<ul style="list-style-type: none"> • Flat ribbon cable is defective • Supply board (A1) or frequency converter (A2) is defective. 	
Delete error code	Carry out a MAINS RESET. Mains switch ON after 2 minutes.

FU / CCI - ERROR 68

Error	Overtemperature in the frequency converter
Consequences of the error	The frequency converter switches off automatically. The rotor slows down unbraked. Further operation is not possible. Further cooling occurs until the set value is achieved.
Cause of error	<ul style="list-style-type: none"> • Also see General notes for FU / CCI - ERROR 61 to FU / CCI - ERROR 69 • The heat transfer from the frequency converter to the centrifuge housing is insufficient. There is no or too little heat conduction paste between the frequency converter and the housing. • Full load operation and an ambient temperature > 45 °C • Flat ribbon cable is defective • Supply board (A1) or frequency converter (A2) is defective.
Delete error code	Carry out a MAINS RESET. Mains switch ON after 2 minutes.

FU / CCI - ERROR 69

Error	EEPROM in the frequency converter is defective
Consequences of the error	The frequency converter switches off automatically. The rotor slows down unbraked. Further operation is not possible. Further cooling occurs until the set value is achieved.
Cause of error	<ul style="list-style-type: none">• Also see General notes for FU / CCI - ERROR 61 to FU / CCI - ERROR 69• Flat ribbon cable is defective• Frequency converter (A2) is defective• Supply board (A1) is defective
Delete error code	Carry out a MAINS RESET. Switch on the mains switch again after 2 minutes.

CONTROL - ERROR 90

Error	Error in the EPROM of the S-control panel
Consequences of the error	Further operation is not possible.
Cause of error	<ul style="list-style-type: none">• S-control panel (A5) is defective.
Delete error code	Carry out a MAINS RESET. If the error cannot be deleted, replace the S-control panel (A5).

CONTROL - ERROR 91

Error	Error in the RAM of the S-control panel
Consequences of the error	Further operation is not possible.
Cause of error	<ul style="list-style-type: none">• S-control panel (A5) is defective.
Delete error code	Carry out a MAINS RESET. If the error cannot be deleted, replace the S-control panel (A5).

CONTROL - ERROR 92

Error	Difference in the memory areas of RAM and EEPROM.	
Consequences of the error	Display	→ CONTROL - ERROR 92 → BATT flashes.
Cause of error/ elimination	<ul style="list-style-type: none"> • If BATT flashes, the battery is either not connected or empty. Connect or replace the battery and re-initialize the centrifuge (see chapter "Initialization"). • If BATT does not flash, the S-control panel (A5) is defective. Replace the S-control panel (A5) and re-initialize the centrifuge (see chapter "Initialization"). <p>If you do not have a new S-control panel or new battery, you can re-initialize the S-control panel. However, you may no longer switch off the mains switch of the centrifuge in this case.</p>	
Delete error code	<ul style="list-style-type: none"> • Carry out a MAINS RESET. • Re-initialization occurs for 30 seconds after the mains switch is switched on. Nothing may be operated during this period. After these 30 seconds are over, the error message CONTROL - ERROR 92 is displayed again. • Now carry out a MAINS RESET again. If the error cannot be deleted, the S-control panel (A5) is defective. • Re-initialize the centrifuge (see chapter "Initialization"). 	

CONTROL - ERROR 94

Error	Error in program flow: Watchdog Hardware error in the S-control panel	
Consequences of the error	Further operation is not possible.	
Cause of error	<ul style="list-style-type: none"> • Incorrect program flow with program interruption • S-control panel (A5) is defective. 	
Delete error code	Carry out a MAINS RESET. If the error cannot be deleted, replace the S-control panel (A5).	

CONTROL - ERROR 95

Error	Error in program flow: impermissible operating state	
Consequences of the error	Further operation is not possible.	
Cause of error	<ul style="list-style-type: none"> • Impermissible operating state was determined. • S-control panel (A5) is defective. 	
Delete error code	Carry out a MAINS RESET. If the error cannot be deleted, replace the S-control panel (A5).	

N > ROTOR - MAX 96

Error	Error in the entered program
Consequences of the error	Further operation is not possible.
Cause of error	SET speed or SET RCF is higher than the permissible rotor speed or permissible rotor RCF.
Delete error code	Open the lid. Reduce the speed or RCF in the entered program to the permissible rotor speed or permissible rotor RCF.

CONTROL - ERROR 97

Error	Error in the EEPROM of the S-control panel
Consequences of the error	Further operation is not possible.
Cause of error	<ul style="list-style-type: none">• S-control panel (A5) is defective.
Delete error code	Carry out a MAINS RESET. If the error cannot be deleted, replace the S-control panel (A5).

CONTROL - ERROR 99

Error	Hardware error in the error management of the S-control panel
Consequences of the error	Further operation is not possible.
Cause of error	<ul style="list-style-type: none">• Fault in the error management• S-control panel (A5) is defective.
Delete error code	Carry out a MAINS RESET. If the error cannot be deleted after re-initialization, replace the S-control panel (A5).

INDEFINITE

Error	not specified error.
Consequences of the error	Further operation is not possible.
Cause of error	<ul style="list-style-type: none">• EPROM is defective• S-control panel (A5) is defective.
Delete error code	Carry out a MAINS RESET. If error cannot be reset, replace EPROM or S-control panel (A5).

BATT

Note	The battery voltage is measured by the processor: 1. once after every MAINS RESET 2. at intervals of 30 minutes.
Error	Battery voltage is too low
Consequences of the error	BATT is displayed. BATT flashes during standstill. After the BATT warning is displayed, the centrifuge can be switched off for at least two weeks without any data loss in the control panel. Mount a new battery or replace the S-control panel during this period. If the battery voltage continues to fall, the information saved in the RAM could become invalid. After the mains switch is switched on, the error CONTROL - ERROR 92 is displayed (see error CONTROL – ERROR 92).
Cause of error/measurements	<ul style="list-style-type: none">• The battery is not connected. Connect the battery and re-initialize the centrifuge (see chapter "Initialization").• The battery is empty. Voltage < 2.2 V. Replace the battery and re-initialize the centrifuge (see chapter "Initialization").

5 Settings and interrogations

5.1 Option: program linkage (only for S-control panel)

To activate program linkage, plug a jumper at position B.6 on the coding strip of the supply board.

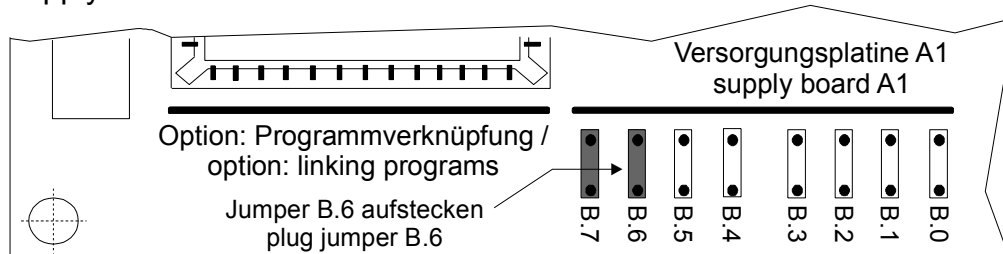

Several centrifugation runs can be linked together with the help of the program linking function.

5.1.1 Linking programs



Program linking is only possible with programs in which run-up and braking steps have been set.

Before linking, the programs must be stored in the desired sequence either by entering the program or by calling up the program (see operating instructions, chapter "Programming").

The program locations must be consecutive (e.g. program locations 10+11+12).

1. Press the **PROG** key in order to select the parameter PROG-Nr. The input field will be displayed inversely.
2. Set the program location for the first program (XX+) by means of the control knob \odot .
3. Press the **RCL** key. The centrifugation data for the selected program location will be displayed.
4. Press the **PROG** key twice in order to select the parameter PR-PART. The input field will be displayed inversely.
5. Press the **STO** key twice. The program will be linked and the program number for the next program location (+XX+) will be displayed.
6. Press the **RCL** key twice. The centrifugation data for the selected program location will be displayed.
7. Press the **STO** key twice. The program will be linked and the program number for the next program location (+XX+) will be displayed.
8. Keep repeating steps 6 and 7 until all programs have been linked.
9. Press the **PROG** key to exit. The program number for the last program (+XX) will be displayed.

5.1.2 Changing program links

- Call up the desired program (see operating instructions, chapter "Calling up programs"), change the desired parameters (see operating instructions, chapter "Entering centrifugation parameters"), and save the modified centrifugation data to the same program location (see operating instructions, chapter "Entering / modifying programs"). As a result of saving, the program linking will be removed.
- Re-link the programs (see chapter "Linking programs").

5.1.3 Centrifugation run with program linking

- Press the **[PROG]** key twice in order to select the parameter PR-PART. The input field will be displayed inversely.
- Set the program location for the first program (XX+) by means of the control knob **○**.
- Press the **[RCL]** key. The centrifugation data for the selected program location will be displayed.
- Press the **[START]** key. The rotation indicator **○** will appear as long as the rotor is turning. The run-up and braking steps for the program linking will be displayed:

 First program (XX+)
PR-PART x: Run-up step for the first program

 Next program (+XX+)
PR-PART x: Run-up step for the next program

 Last program (+XX)
PR-PART x: Run-up step for the last program
 y: Braking step for the last program

- When the time in the last program has expired, run-down will take place with the braking step of the last program. If the centrifugation run is interrupted by pressing the **[STOP]** key, run-down will take place with the braking step of the program running at the time.

5.1.4 Deleting program linking

- Press the **[PROG]** key in order to display the parameter PROG-No. The input field will be displayed inversely.
- Set the program location for the first program (XX+) by means of the control knob **○**.
- Press the **[RCL]** key. The centrifugation data for the selected program location will be displayed.
- Press the **[PROG]** key twice in order to display the parameter PR-PART. The input field will be displayed inversely.
- Press the **[STO]** key twice.
- Press the **[PROG]** key.

5.2 Option: optical interface (only for S-control panel)

In centrifuges with an optical interface, a jumper must be plugged at position B.4 on the coding strip of the supply board.

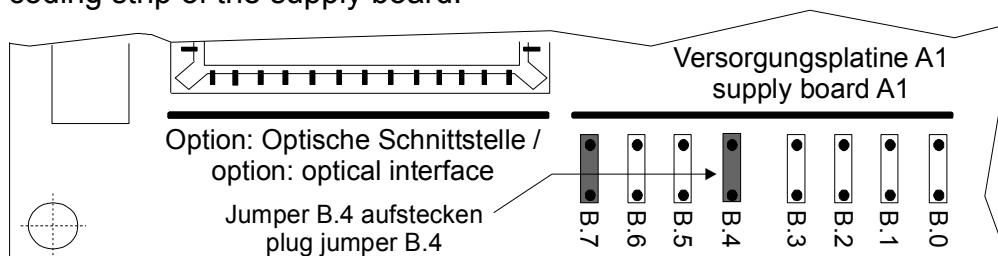

5.3 Option: key-operated switch (only for S-control panel)

The key-operated switch must be plugged on plug X27 on the supply board (A1). Installation of the key-operated switch see chapter "Mounting and removing components".

The following program interlocks can be set by the key-operated switch:

Left key position: **LOCK 1** will be displayed.

Programs can be called up but not changed.

Right key position: **LOCK 2** will be displayed.

No programs can be called up or changed.

Middle key position: No status display.

No program interlock. Programs can be called up and changed.

5.4 Setting the lid lock mode

There is a coding strip on the supply board for setting the mode of the lid lock.

Mag = manual lid lock

Mot = motor-driven lid lock

The jumper must be plugged to the right side "Mot" (see figure).

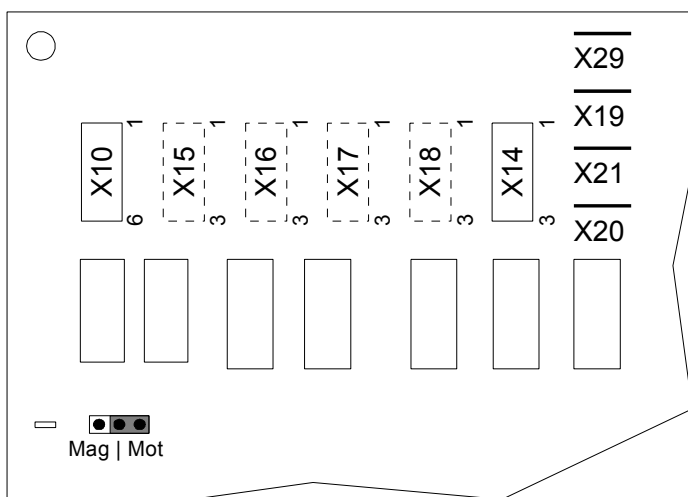

5.5 Setting the machine and cooling version

Set the machine and cooling version of the centrifuge on the supply board by plugging the corresponding jumpers on the coding strip.

ROTANTA 460 / 460 S Maschinen-, Kühlungsversion / machine-, cooling-version

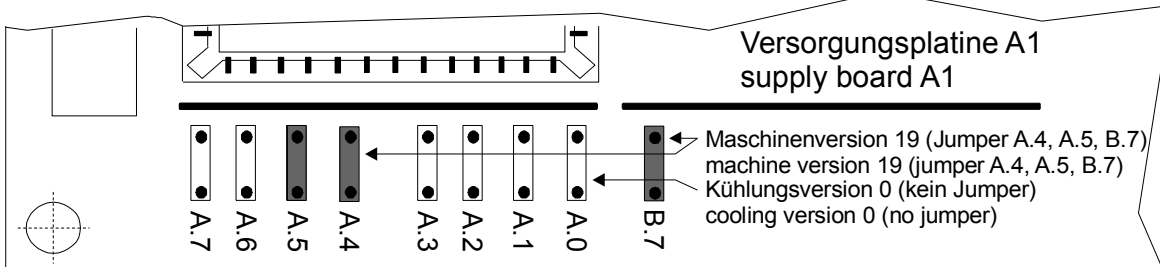

ROTANTA 460 R / 460 RS Maschinen-, Kühlungsversion / machine-, cooling-version

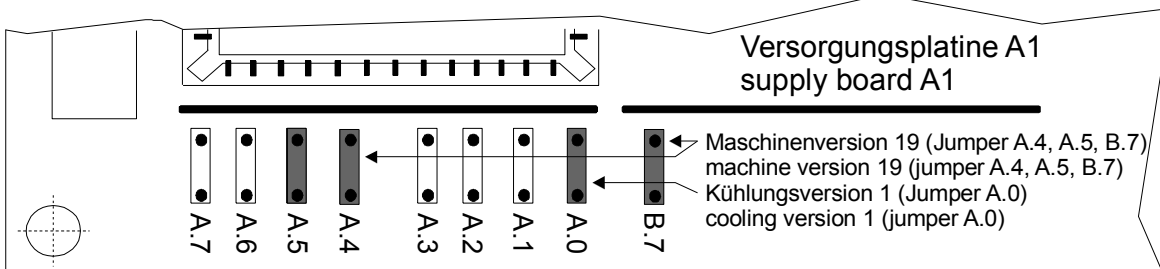

ROTANTA 460 RH / 460 RSH Maschinen-, Kühlungsversion / machine-, cooling-version

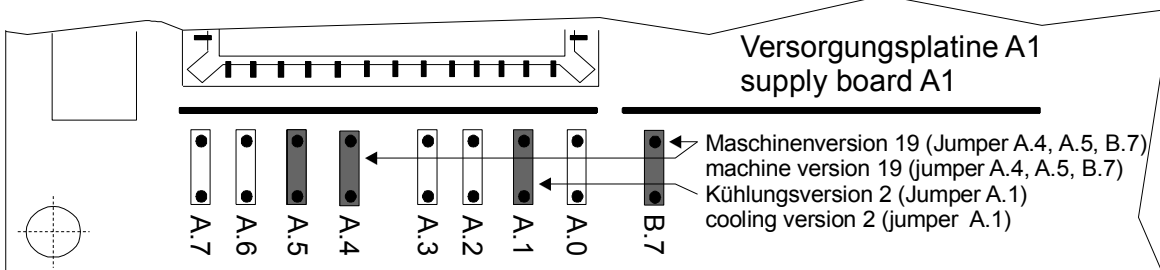

ROTANTA 460 T / 460 ST Maschinen-, Kühlungsversion / machine-, cooling-version

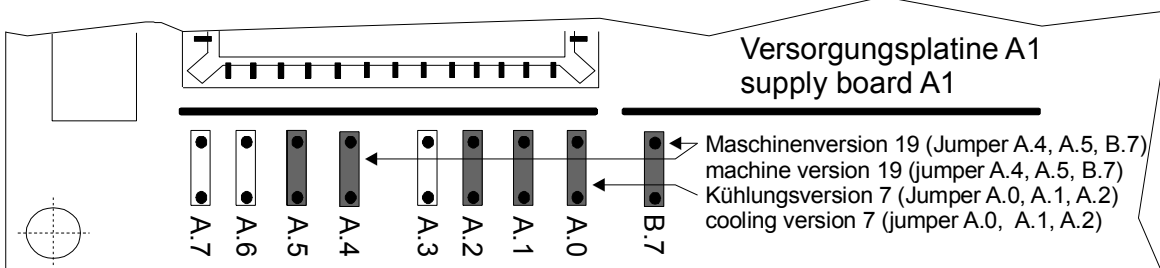

5.6 Function of the additional jumper

There is an additional jumper at position B.0-B.1 on the coding strip of the supply board. This jumper is used for selecting the initialization mode and the offset mode. After the above modes are over, you must re-plug this jumper to position B.0-B.1 specified below.

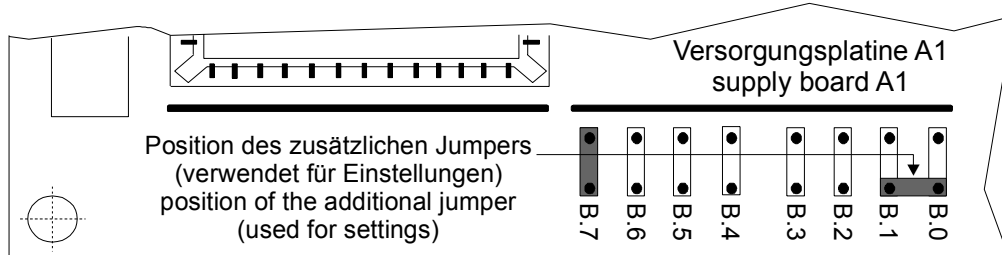

5.7 Initialization

Initialization means adjusting the components (S-control panel, coding strip on the supply board and frequency converter) to the centrifuge.

Observe the following instructions when replacing the above mentioned components:

- Plug the jumpers on the coding strip of the supply board in accordance with the machine and cooling version (see chapter "Setting the machine and cooling version").
- The frequency converter must be adjusted to the centrifuge.
- The S-control panel must be adjusted to the centrifuge.
- The suitable EPROM for the machine version must be plugged in the N-control panel.

If the above settings do not match, **VERSION - ERROR 12** is displayed after the mains supply is switched on.

5.7.1 Prerequisites for the initialization

An initialization can be carried out only if the rotor has standstill and the lid is open.

Before the initialization:

- Open the lid.
- Switch off the mains switch.
- Plug the additional jumper on the coding strip of the supply board at position B.1 (see chapter "Function of the additional jumper").

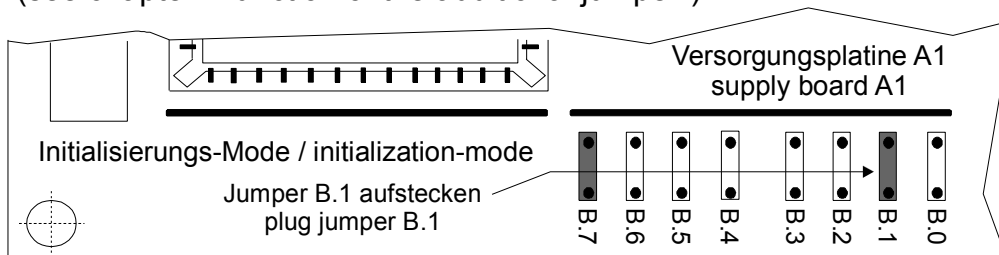

5.7.2 Initializing the centrifuge with N-control panel

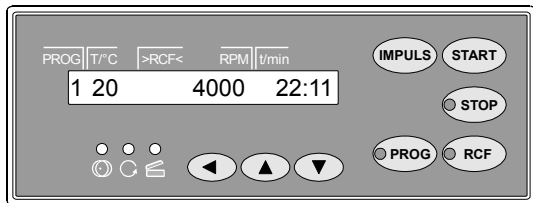

An initialization must be carried out:

- after replacing the frequency converter.

The frequency converter must be adjusted to the centrifuge.

Example for ROTANTA 460 R:

Action	Display / Comment
1. Prepare the centrifuge for the initialization (see chapter "Prerequisites for the initialization").	
2. Switch on the mains switch. Display after approx. 8 s	→ ROTANTA460RVx.xx → * INIT_MODE * (If OPEN LID! is displayed, the lid must be opened)
3. Press the ◀ key.	→ VERS 19 °C/* 01 <div style="display: flex; justify-content: space-around; align-items: center;"> <div style="text-align: center;"> ↑ Machine version </div> <div style="text-align: center;"> ↑ Cooling version </div> </div>
4. Press the ◀ key.	→ IMBALANCE MODE 2 IMBALANCE MODE 2 must be set. Explanation see chapter "Imbalance Mode".
5. Press the ◀ key to display the next parameter or use the ▲ and ▼ keys to set Imbalance Mode 2 and afterwards press the START key to save the setting.	→ TEMP.AVERAGE 30 (is only displayed with centrifuges with cooling) Explanation see chapter "Temp. Average Time".
6. Press the ◀ key to display the next parameter or use the ▲ and ▼ keys to set the Temp. Average time and afterwards press the START key to save the setting.	→ LEADING TIME 0 (is only displayed with centrifuges with cooling) 0 = no leading time has been set. Explanation see chapter "Leading time".
7. Press the ◀ key to display the next parameter or use the ▲ and ▼ keys to set the leading time and afterwards press the START key to save the setting.	→ E58 DIFF = 5 °C (is only displayed with centrifuges with cooling) Explanation see chapter "Parameter for error message °C / *ERROR 58".

Action

Display / Comment

8. Press the key to display the next parameter or use the and keys to set the temperature monitor and afterwards press the **(START)** key to save the setting.

→ **PARAM_INIT 0000**
 Machine version
 Number of initializations

9. Press the **(START)** key.

→ ***** OK ***** afterwards
PARAM_INIT 3001
 Machine version
 Number of initializations

10. Switch off the mains switch.

11. Remove the additional jumper on the coding strip of the supply board from position B.1 and plug it at position B.0-B.1 again (see chapter "Function of the additional jumper").

5.7.3 Initializing the centrifuge with S-control panel

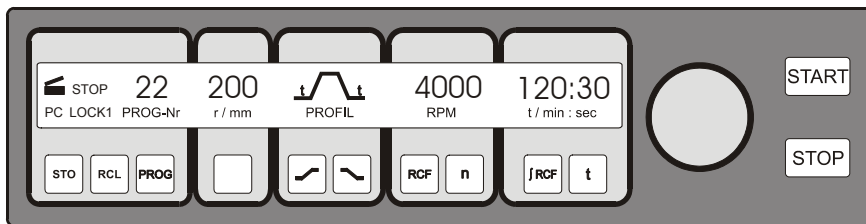

Before starting with initialization, connect the battery of the S-control panel. Close contact 1 on the DIP switch. To do so, press the spring downward, lock it into place and solder it. The contacts 2 to 5 must be open.

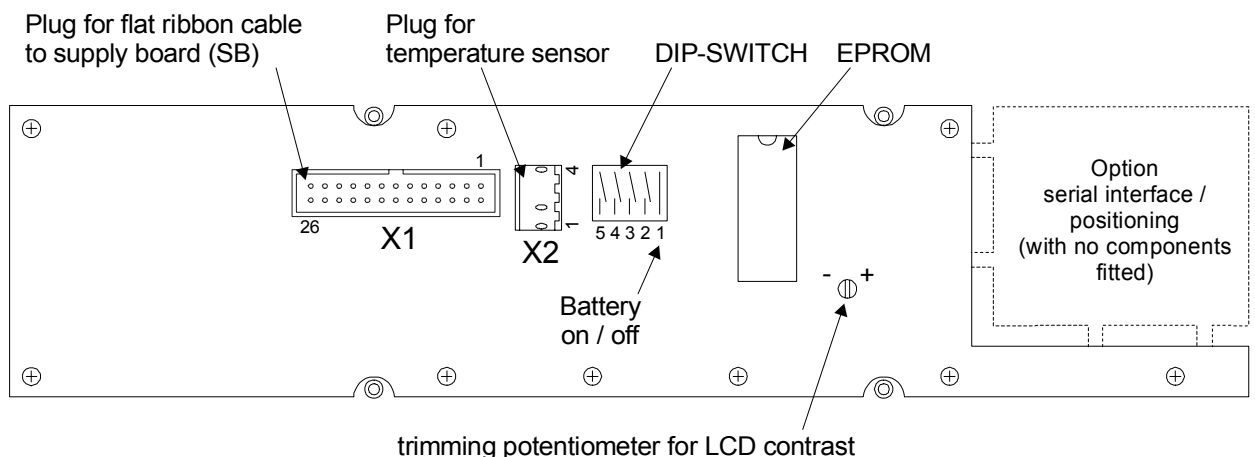

An initialization must be carried out:

- after replacing the S-control panel.
- after replacing the EPROM on the S-control panel,
- after replacing the frequency converter.

The S-control panel and the frequency converter must be adjusted to the centrifuge.

Action	Display / Comment
8. Press the START key.	→ *** OK *** (Frequency converter is initialized) afterwards FU / CCI - TYP 1204 SOFTWARE 203.1 ADDRESS A PARAM-INIT 3111 ↑ Still no date is set in the S-control panel.
9. Press the PROG key.	→ IMBALANCE MODE 2 IMBALANCE MODE 2 must be set. Explanation see chapter "Imbalance Mode".
10. Use the control knob \odot to set imbalance mode 2 and afterwards press the START key to save the setting.	→ *** OK ***
11. Press the PROG key.	→ TEMP.AVERAGE 30 (is only displayed with centrifuges with cooling) Explanation see chapter "Temp. Average Time".
12. Use the control knob \odot to set the temp. average time and afterwards press the START key to save the setting.	→ *** OK ***
13. Press the PROG key.	→ LEADING TIME / S 0 (is only displayed with centrifuges with cooling) 0 = no leading time has been set. Explanation see chapter "Leading time".
14. Use the control knob \odot to set a leading time and afterwards press the START key to save the setting.	→ *** OK ***
15. Switch off the mains switch.	
16. Remove the additional jumper on the coding strip of the supply board from position B.1 and plug it at position B.0-B.1 again (see chapter "Function of the additional jumper").	

If the date and time have not yet been saved in the S-control panel, the date and time display will appear the next time you switch on the centrifuge (a: year, mon: month, d: day, h: hours, min: minutes). Further operation is possible only after entering the date and time.

Set the date and time as described below:

1. Press the key to select the parameter (a: year, mon: month, d: day, h: hours, min: minutes) and make a setting with the control knob \odot .
2. After you have entered all values, press the **START** key in order to save the settings.
***** ok ***** is displayed for a short time to confirm that the settings have been saved.

5.8 OFFSET compensation

The offset compensation is carried out to correct the measurement deviations of the temperature sensors (T1, T2, T3) and the supply board (A1). The OFFSET values are saved in the control panel.

T1 = temperature sensor at the top of the centrifuge chamber

T2 = temperature sensor at the bottom of the centrifuge chamber

T3 = temperature sensor on the condenser

OFFSET value = (corrected temperature) - (temp. measured by the temp. sensor).

Example:

Display:	Temperature measured by the temp. sensor	Corrected temperature (ACTUAL temperature)
T1 =	27.0°C	25.5°C

OFFSET value = $25.5^{\circ}\text{C} - 27.0^{\circ}\text{C} = -1.5^{\circ}\text{C}$

An OFFSET compensation must be carried out:

- after replacing a temperature sensor (T1, T2, T3),
- after replacing the EPROM on the N- or S-control panel,
- after replacing the N- or S-control panel,
- after replacing the supply board.

To carry out an offset compensation, measure the temperature directly on each temperature sensor with a temperature measuring device. Then enter the measured values in the display and save them.

Confirm every input by pressing the **START** key.

The temperature at the temperature sensors should be constant during the offset compensation so that no measurement errors are made.

An OFFSET compensation can be carried out only if the rotor has standstill and the lid is open.

Action

Display / Comment

1. Open the lid.
2. Switch off the mains switch.
3. Plug the additional jumper on the coding strip of the supply board at position B.0 (see chapter "Function of the additional jumper").

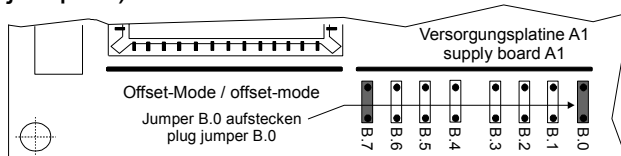



4. Switch on the mains switch.

→ **ROTANTA460RVx.xx**
(only with N-control panel)

Display after approx. 8 s

→ * **OFFSET - MODE** *
(If the  symbol flashes on the S-control panel or **OPEN LID!** is displayed with the N-control panel, the lid must be opened.)



5. Press the  key on the N-control panel. Press the  key on the S-control panel.

→ **T1: xx,xC → xx,xC** (N-control)
T1 = xx.xC xx.xC (S-control)

↑
corrected temperature
(ACTUAL temperature)

↑
temperature measured by
the temperature sensor

↑
designation of the temp. sensor

6. Use the  and  keys to set the ACTUAL temperature measured with the temperature measuring device at the temperature sensor on the N-control panel and the control knob  to set it on the S-control panel and afterwards press the **START** key to save the setting.

→ ***** OK ***** afterwards

T1: xx,xC → xx,xC (N-control)
T1 = xx.xC xx.xC (S-control)

7. Repeat the steps 5 and 6 until the ACTUAL temperatures of all temperature sensors (T1 up to T3) have been entered.
8. Switch off the mains switch.
9. Remove the additional jumper on the coding strip of the supply board from position B.0 and plug it at position B.0-B.1 again (see chapter "Function of the additional jumper").

The offset value must be corrected if the temperature in the samples deviates from the SET value during a test run.

- Sample temperature is lower than the SET temperature:
Reduce the OFFSET value of T1 and T2 by the difference
- Sample temperature is higher than the SET temperature:
Increase the OFFSET value of T1 and T2 by the difference

5.9 Imbalance Mode

The imbalance mode must be set on the supply board and in the program.

5.9.1 Setting the imbalance mode on the supply board

A jumper must be plugged on plug X8 at position pin 3-5 (factory setting), see figure.

X8

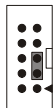

5.9.2 Setting the imbalance mode in the program

The setting of the imbalance mode can be carried out only if the rotor has standstill and the lid is open.

Action

Display / Comment

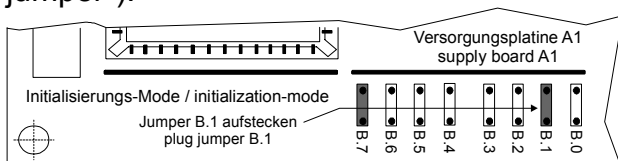

1. Open the lid.
2. Switch off the mains switch.
3. Plug the additional jumper on the coding strip of the supply board at position B.1 (see chapter "Function of the additional jumper").



4. Switch on the mains switch.

Display after approx. 8 s

- **ROTANTA460RVx.xx**
(only with N-control panel)
- *** INIT_MODE ***
(If the  symbol flashes on the S-control panel or **OPEN LID!** is displayed with the N-control panel, the lid must be opened.)

5. Press the  key on the N-control panel and the  key on the S-control panel so often until the following appears in the display.

- **IMBALANCE MODE 2**
IMBALANCE MODE 2 must be set.

Action

Display / Comment

6. Use the ▲ and ▼ keys to set Imbalance Mode 2 on the N-control panel and the control knob ○ to set it on the S-control panel and afterwards press the **START** key to save the setting. → ***** OK *****
7. Switch off the mains switch.
8. Remove the additional jumper on the coding strip of the supply board from position B.1 and plug it at position B.0-B.1 again (see chapter "Function of the additional jumper").

5.10 Temp. Average Time

The setting of the temp. average time can be carried out only with centrifuges with cooling, with N-control panel from program version V4.03 and with S-control panel from program version V5.580.

After start of a centrifugation run in the display still another certain time the temperature set value is indicated, before the actual temperature will be displayed.

This time until the actual temperature is displayed is called temp. average time. It can be set from 5 to 180 seconds, in steps of 1 second and is pre-set to 30 seconds.

The setting of the temp. average time can be carried out only if the rotor has standstill and the lid is open.

Action

Display / Comment

1. Open the lid.
2. Switch off the mains switch.
3. Plug the additional jumper on the coding strip of the supply board at position B.1 (see chapter "Function of the additional jumper").

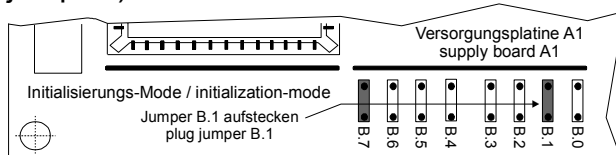





4. Switch on the mains switch.

Display after approx. 8 s

→ **ROTANTA460RVx.xx**
(only with N-control panel)

→ *** INIT_MODE ***
(If the  symbol flashes on the S-control panel or **OPEN LID!** is displayed with the N-control panel, the lid must be opened.)

Action	Display / Comment
5. Press the  key on the N-control panel and the PROG key on the S-control panel so often until the following appears in the display.	→ TEMP.AVERAGE 30
6. Use the  and  keys to set the Temp Average Time on the N-control panel and the control knob  to set it on the S-control panel and afterwards press the START key to save the setting.	→ *** OK ***
7. Switch off the mains switch.	
8. Remove the additional jumper on the coding strip of the supply board from position B.1 and plug it at position B.0-B.1 again (see chapter "Function of the additional jumper").	

5.11 Leading time

The setting of the leading time can be carried out only with centrifuges with cooling, with N-control panel from program version V4.03 and with S-control panel from program version V5.520.

During centrifugation runs with low speeds and/or long slowing down periods, the samples could get undercooled while the system comes to a stop.

To avoid this too low temperature in the samples the cooling system may not switch on a short time before the running time is over. If the cooling system is switched on at this time, it will be switched off.

This period between the switching off the cooling system and the end of the running time is called "leading time". It can be set from 0 to 180 seconds.





The leading time has no relevance in centrifugation runs with the continuous operation setting or if the centrifugation run is interrupted by pressing the **STOP** key.

The factory setting of the centrifuge is leading time = 0 (switched off).

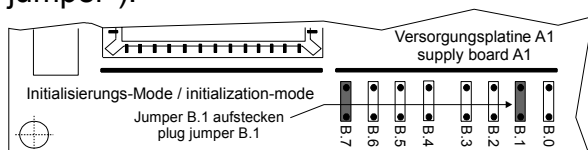
The setting of the leading time can be carried out only if the rotor has standstill and the lid is open.

Action	Display / Comment
1. Open the lid.	
2. Switch off the mains switch.	
3. Plug the additional jumper on the coding strip of the supply board at position B.1 (see chapter "Function of the additional jumper").	



Action	Display / Comment
4. Switch on the mains switch. Display after approx. 8 s	→ ROTANTA460RVx.xx (only with N-control panel) → * INIT_MODE * (If the  symbol flashes on the S-control panel or OPEN LID! is displayed with the N-control panel, the lid must be opened.)
5. Press the  key on the N-control panel and the PROG key on the S-control panel so often until the following appears in the display.	→ LEADING TIME 0 (N-control) LEADING TIME / S 0 (S-control) 0 = no leading time has been set.
6. Use the  and  keys to set the leading time on the N-control panel and the control knob  to set it on the S-control panel and afterwards press the START key to save the setting.	→ *** OK ***
7. Switch off the mains switch.	
8. Remove the additional jumper on the coding strip of the supply board from position B.1 and plug it at position B.0-B.1 again (see chapter "Function of the additional jumper").	

5.12 Parameter for error message °C / *ERROR 58

The setting of the parameters can be carried out only with centrifuges with cooling.

5.12.1 Temperature monitor until reaching the temperature set value

After start of a centrifugation run, when the temp. average time has expired, the march of temperature is monitored until the temperature set value will be reached. The temperature in the centrifuge chamber must approach the temperature set value.

When the temperature moves into the opposite direction up to an adjusted value, the centrifugation run stops to protect temperature sensitive samples and the error message **°C / *ERROR 58** will be displayed.

The temperature range can be set from 5°C to 10°C. The factory setting of the centrifuge is 5°C.

The setting of the temperature monitor can be carried out only if the rotor has standstill and the lid is open.

5.12.1.1 Setting the temperature monitor with the N-control panel

Can be set with N-control panel from program version V4.03.

Action

Display / Comment

1. Open the lid.
2. Switch off the mains switch.
3. Plug the additional jumper on the coding strip of the supply board at position B.1 (see chapter "Function of the additional jumper").

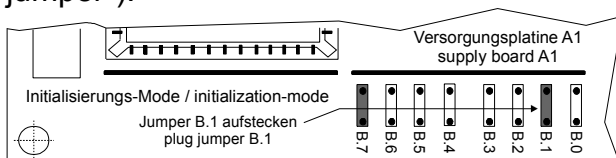

4. Switch on the mains switch. → **ROTANTA460RVx.xx**
 Display after approx. 8 s → *** INIT_MODE ***
 (If **OPEN LID!** is displayed, the lid must be opened.)
5. Press the ◀ key so often until the following → **E58 DIFF = 5 °C**
 appears in the display.
6. Use the ▲ and ▼ keys to set the desired → ***** OK *****
 value and afterwards press the **START** key
 to save the setting.
7. Switch off the mains switch.
8. Remove the additional jumper on the coding strip of the supply board from position B.1 and plug it at position B.0-B.1 again (see chapter "Function of the additional jumper").

5.12.1.2 Setting the temperature monitor with the S-control panel

Can be set with S-control panel from program version V5.580.

- Switch on the mains switch.
- Open the lid.
- Switch the mains switch off and on again. Switch position I.
- Press the **STOP** key when the first visual change appears in the display (inverse display). **PROGRAM 1, LAST PROGRAM** will be displayed.
- Press the **STOP** key so often until **E58 DIFF = 5** will be displayed.
- Set the desired value by means of the control knob \odot .
- Press the **START** key to save the setting.
***** ok ***** will be displayed briefly as a confirmation.

5.12.2 Permissible temperature difference after reaching the temperature set value

After reaching the set temperature once, the temperature will be monitored permanently.





When the temperature deviates for more than 120 seconds from an adjusted value of the set temperature, the centrifugation run stops to protect temperature sensitive samples and the error message °C / ***ERROR 58** will be displayed.

The temperature range can be set from $\pm 5^{\circ}\text{C}$ to $\pm 25^{\circ}\text{C}$. The factory setting of the centrifuge is $\pm 15^{\circ}\text{C}$.

5.12.2.1 Setting the permissible temperature difference with the N-control panel

Can be set with N-control panel from program version V4.03.

The setting of the temperature range can be carried out only if the rotor has standstill.

- Hold down the key  for 8 seconds.
After 8 seconds, **SOUND / BELL** appears in the display.
- Press the  key so often until **ERROR 58 = 15 °C** will be displayed.
- Press the **RCF** key.
- Set the desired value with the  and  keys.
- Press the key **START** to save the setting.
As confirmation, ***** ok ***** will be displayed for a short period.

5.12.2.2 Setting the permissible temperature difference with the S-control panel

Can be set with S-control panel from program version V5.530.







The setting of the temperature range can be carried out only if the rotor has standstill and the lid is open.

- Switch on the mains switch.
- Open the lid.
- Switch the mains supply switch off and on again. Switch position I.
- Press the **STOP** key when the first visual change appears in the display (inverse display). **PROGRAM 1, LAST PROGRAM** will be displayed.
- Press the **STOP** key again.
ERROR TEMPERATUR + / - 15°C will be displayed.
- Set the desired value by means of the control knob .
- Press the **START** key to save the setting.
As confirmation, ***** ok ***** will be displayed for a short period.



5.13 Parameter interrogation

It is only possible to interrogate the parameters when the rotor is at standstill.

5.13.1 Parameter interrogation N-control panel

- Keep the  key pressed (approx. 8 s) until the following is displayed:
 1. **SOUND / BELL ON** Acoustic signal
 or OFF
 - Press the  key. Whenever you press the  key, the display changes as shown below:
 2. **CONTROL: XXX h** Working hours
 3. **VERS 19 °C / * 01** Machine version, cooling version
 4. **FU/CCI: XX h** Frequency converter working hours
 (period for which the frequency converter
 was connected to the mains supply)
 5. **FU/CCI - 1204** Frequency converter type
 6. **FU/CCI - S. 203.2** Frequency converter software version
 7. **°C / * - S. 01.07** Supply board software version
 8. **ERROR 58 = 15 °C** Temperature difference (°C / *ERROR 58)
 - To exit the parameter interrogation, press any key apart from the ,  and  keys.
- Among the parameters listed here, only parameter 1., 2. and 8. can be changed.

5.13.2 Parameter interrogation S-control panel

- Open the lid.
- Keep the  key pressed (approx. 8 s) until the following is displayed:
 1. **SOUND / BELL ON1** Acoustic signal
 or ON2 or OFF
- Press the  key. Whenever you press the  key, the display changes as shown below:
 2. **CONTROL: XXX h** Working hours
 3. **a mon d h min** Date and time
 4. **VERS 19 °C / * 01** Machine version, cooling version
 5. **FU/CCI: XX h** Frequency converter working hours
 (period for which the frequency converter
 was connected to the mains supply)
 6. **FU/CCI - 1204** Frequency converter type
 7. **FU/CCI - S. 203.2** Frequency converter software version
 8. **°C / * - S. 01.07** Supply board software version

If you do not press any key for 8 seconds, the centrifugation data will be displayed again.

Among the parameters listed here, only parameter 1. , 2. and 3. can be changed.

5.14 Acoustic Signal





5.14.1 Acoustic Signal N-control panel

The acoustic signal sounds:

- Upon the appearance of a disturbance in 3 second intervals.
- After completion of a centrifugation run and rotor standstill in 30 second intervals.

The acoustic signal is stopped by opening the lid or pressing any key.

The signal can be activated or deactivated after completion of the centrifugation run (if the rotor is at standstill) in the following manner:

- Hold down the key  for 8 seconds.
After 8 seconds, **SOUND / BELL XXX** appears in the display.
- Set **OFF** or **ON** with the key  or .
- Press the key  in order to store the setting.
As confirmation, ***** ok ***** will be displayed for a short period.



5.14.2 Acoustic signal S-control panel

The acoustic signal sounds in accordance with the following philosophy:

OFF	<ul style="list-style-type: none"> • at 2 s intervals on the occurrence of a fault
ON1	<ul style="list-style-type: none"> • at 2 s intervals on the occurrence of a fault • at 30 s intervals on completion of a centrifugation run and the rotor coming to rest.
ON2	<ul style="list-style-type: none"> • at 2 s intervals on the occurrence of a fault • at 30 s intervals on completion of a centrifugation run and the rotor coming to rest. • every time a key is pressed

The audible signal is silenced by opening the lid or pressing any key.





The signal can be set as follows when the rotor is at standstill.

- Open the lid.
- Press and hold the  key for 8 seconds.
After 8 seconds **SOUND / BELL XXX** will be displayed.
- Set the desired function (OFF, ON1, ON2) by means of the control knob .
- Press the  key to save the setting.
***** ok ***** will be displayed briefly as a confirmation.

5.15 Working hours

You can check and change the working hours only if the rotor is at standstill.

5.15.1 Working hours N-control panel

- Keep the  key pressed for 8 seconds.
After 8 seconds, **SOUND / BELL XXX** will be displayed.
- Press the  key again.
The working hours (**CONTROL:**) of the centrifuge will be displayed.
- To exit the working hours check screen, press the  or  key.
Press the  key to set the working hours.

- Set the working hours with the ▲ and ▼ keys.
- Press the **START** key to save the setting.
*** ok *** is displayed for a short time to confirm that the setting has been saved.

5.15.2 Working hours S-control panel

- Open the lid.
- Keep the **t** key pressed for 8 seconds.
After 8 seconds, **SOUND / BELL XXX** will be displayed.
- Press the **t** key again.
The working hours (**CONTROL:**) of the centrifuge will be displayed.
The working hours display automatically disappears after 10 seconds.
- Press the **✓** key to set the working hours.
- Set the working hours with the control knob **○**.
- Press the **START** key to save the setting.
*** ok *** is displayed for a short time to confirm that the setting has been saved.

5.16 Checking the motor slippage

The centrifuge control can readjust the speed depending on the rotor.
The error (N < MIN 13) is displayed if the rotor speed (ACTUAL speed) is lower than the permitted range of control.

It is only possible to check the slippage during a centrifugation run.

5.16.1 Checking the slippage with the N-control panel

- Start a centrifugation run and wait until the set speed is achieved.
- Up to program version V4.02 keep the **◀** key pressed and from program version V4.03 keep the **▲** key pressed for 8 seconds. After 8 seconds the following appears in the display:

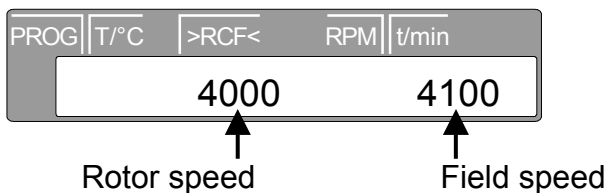

Slippage = (field speed) - (rotor speed)

- From program version V4.03 press the **▼** key to exit the slippage display. Up to program version V4.02 the slippage display automatically disappears after 8 seconds.

5.16.2 Checking the slippage with the S-control panel

It is only possible to check the slippage from program version V5.580.

- Start a centrifugation run and wait until the set speed is achieved.
- Keep the \square key pressed for 8 seconds. After 8 seconds the following appears in the display:

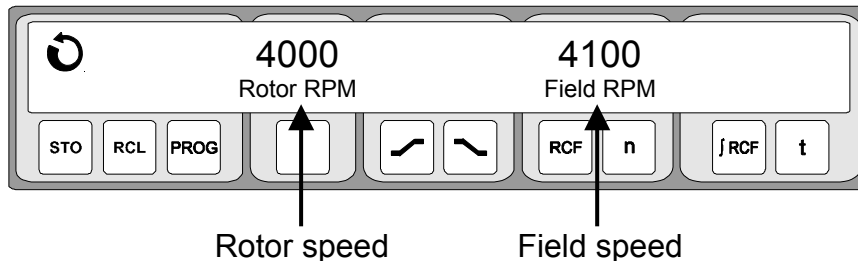

$$\text{Slippage} = (\text{field speed}) - (\text{rotor speed})$$

- To exit the slippage display press the \square key.

5.17 Checking the temperatures

It is only possible to check the temperatures with centrifuges with cooling and during a centrifugation run.

5.17.1 Checking the temperatures with the N-control panel

It is only possible to check the temperatures from programm version V4.03.

- Start a centrifugation run.
- Keep the \blacktriangle key pressed for 8 seconds. After 8 seconds appears the slippage display.
- Press the \blacktriangle key again. The following values will be displayed:

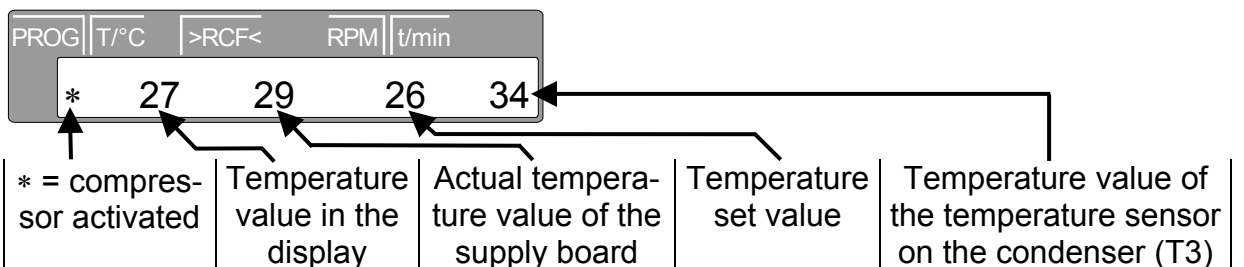

If a jumper will be plugged on the coding strip of the supply board at position B.3, then the actual temperature value of the supply board corresponds to the evaluated sensor temperatures. Sensor evaluation see chapter "Diagram of the cooling version".

- Press the \blacktriangle key again. The following values will be displayed:

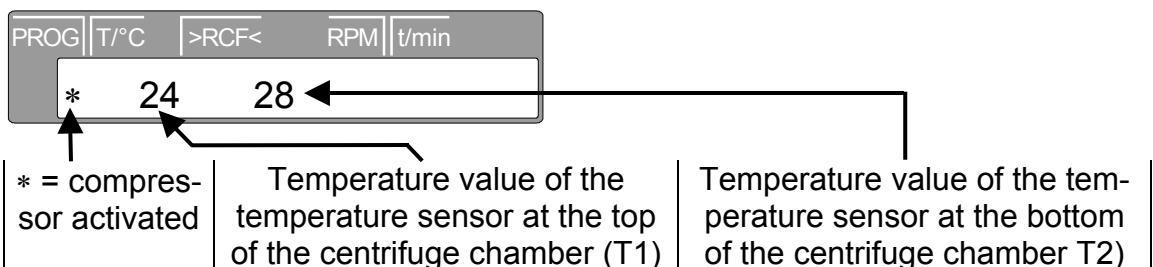

- To exit the temperature display press the \blacktriangledown key.

5.17.2 Checking the temperatures with the S-control panel

It is only possible to check the temperatures from programm version V5.580.

- Start a centrifugation run.
- Keep the key pressed for 8 seconds. After 8 seconds the following appears in the display:

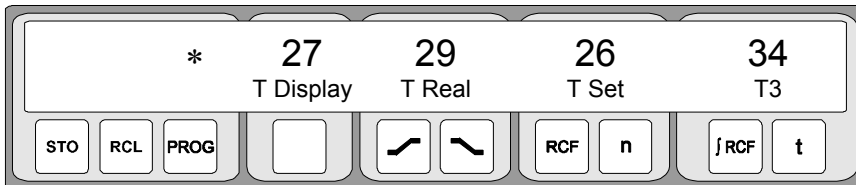

* = compressor activated

T Display = Temperature value in the display

T Real = Actual temperature value of the supply board

T Set = Temperature set value

T3 = Temperature value of the temperature sensor on the condenser

If a jumper will be plugged on the coding strip of the supply board at position B.3, then the actual temperature value of the supply board corresponds to the evaluated sensor temperatures. Sensor evaluation see chapter "Diagram of the cooling version".

- Press the key again. The following values will be displayed:

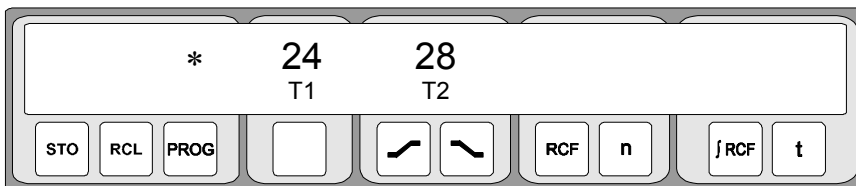

* = compressor activated

T1 = Temperature value of the temp. sensor at the top of the centrifuge chamber

T2 = Temp. value of the temp. sensor at the bottom of the centrifuge chamber

- To exit the temperature display press the key.

5.18 Setting the date and time (only in S-control panel)

It is only possible to set the date and time when the rotor is at standstill.

- Open the lid.
- Press and hold the key for 8 seconds.
After 8 seconds **SOUND / BELL XXX** will be displayed.
- Press the key twice more.
The date and time will be displayed (a: year, mon: month, d: day, h: hours, min: minutes).
- Press the key repeatedly until the input field for the desired parameter is shown inversely.
- Set the desired value by means of the control knob .
- Press the key to save the setting.
***** ok ***** will be displayed briefly as a confirmation.
- To exit the date and time set-up, press any key apart from the , and keys.

5.19 Centrifugation data displayed after switching on (only in S-control)

After switching on, the centrifugation data for program 1 or for the program last used will be displayed. This can be set as follows:

- Open the lid.
- Switch the mains supply switch off and on again. Switch position I.
- Press the **STOP** key when the first visual change appears in the display (inverse display).

PROGRAM 1, LAST PROGRAM will be displayed.

- Set the desired function by means of the control knob \odot .
 - Press the **START** key to save the setting.
- *** ok ***** will be displayed briefly as a confirmation.

5.20 Immediate display of the centrifugation data after switching on (only in S-control panel)

- Switch on the mains supply switch. Switch position I.
- Press any key apart from the **STOP** key when the first visual change appears in the display (inverse display). The centrifugation data will be displayed immediately.

5.21 Logging (only in S-control panel)

The following are saved in the S-control panel:

- the last 11 error messages
- the last 4 imbalance messages
- 7 modification logs

Interrogating messages and changes are only possible when the rotor is at standstill and the lid is open.

- Switch on the mains switch.
- Open the lid.
- Switch off the mains switch and switch it on again. Switch position I.
- When the first visual change occurs in the display (inverse display), press the **STOP** key. **PROGRAM 1, LAST PROGRAM** is displayed.
- Press the **STOP** key so often until the first error message will be displayed.
- Press the **t** key to display the next error message.
The error messages, imbalance messages and modification logs are displayed one after the other.
- To exit the display, press any key except for the **t** key.

Rear side of the N-control panel:

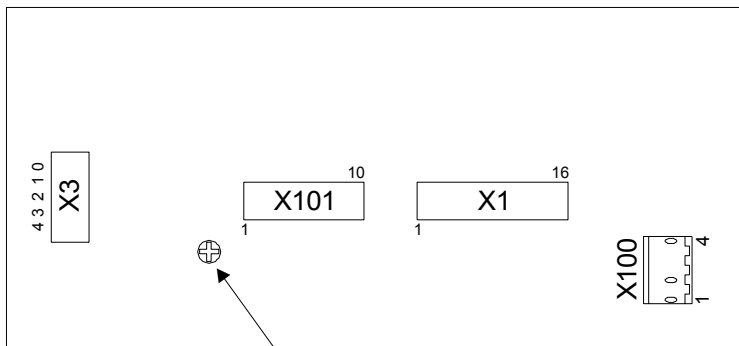

trimming-potentiometer for LCD-contrast

Rear side of the S-control panel:

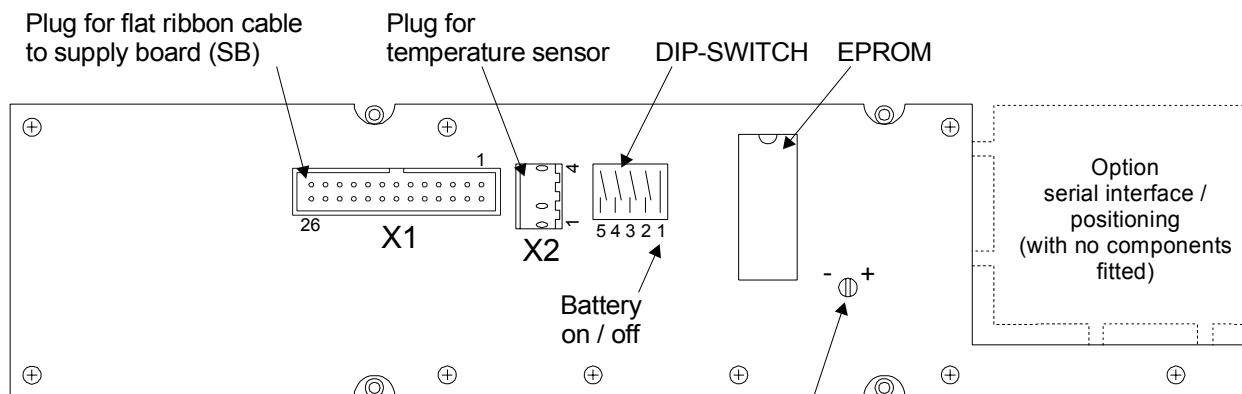

trimming potentiometer for LCD contrast

Set the contrast in such a way that the background pixel are visible.

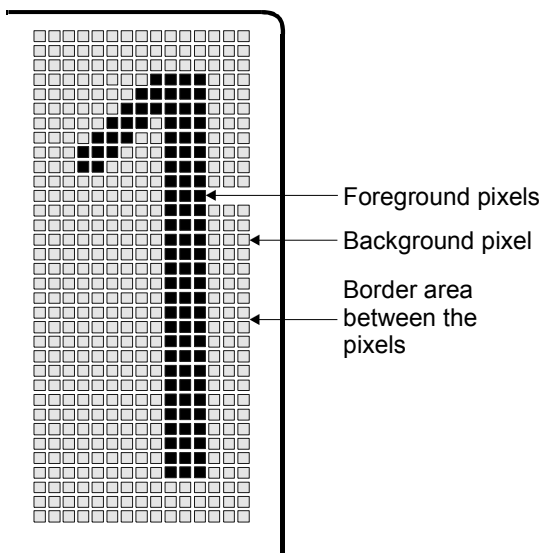

5.23 Imbalance switch-off

The permissible imbalance is specified for rotor 4444 by the indication of the difference in weight of opposite rotor positions.

When having a difference in weight within the range of 30g to 45g during run-up, the drive has to switch off before reaching 1500 RPM.

The imbalance switch-off is adjusted by changing the distance of the imbalance switch.

With a test run with the indicated differences in weight the imbalance switch-off will be checked.

Adjusting the imbalance switch:

With centrifuges up to serial no. XXXX-01-XX:

- Loosen both screws at the angle bracket of the imbalance switch on the outer part of the housing floor until you can shift it.
- Set the permissible imbalance by shifting the angle bracket.
- Tighten both screws at the angle bracket of the imbalance switch again.
- Check the imbalance switch-off with a test run.

With centrifuges from serial no. XXXX-02-XX:

- Remove the front panel as described in chapter "Removing the front panel".
- Insert the hexagon socket head wrench (rotor tool) horizontally in the drilling (Fig. 1, Fig. 2, a) in the lower part of the housing and stick it into the adjusting screw (Fig. 2, b) of the imbalance switch, located at the angle bracket.
- Set the permissible imbalance by turning the hexagon socket head wrench (rotor tool). By turning anticlockwise the permissible imbalance will be reduced, by turning clockwise the permissible imbalance will be arisen.
- Check the imbalance switch-off with a test run.

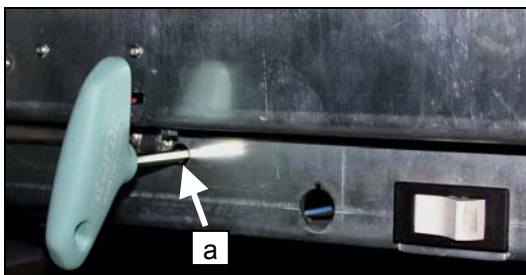

Fig. 1

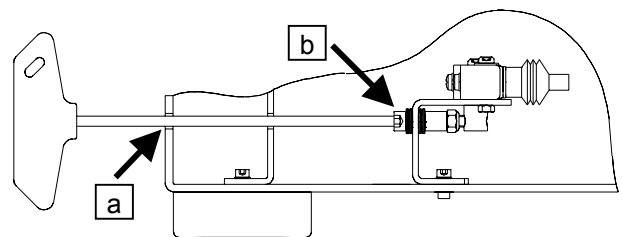

Fig. 2

6 Functional check after a repair

After a repair a functional check of the unit must be carried out.

For functional check a test run with the loaded rotor must be performed.

During the test run the followings must be checked:

- Function of the keys, the display and the LEDs of the N-control panel.
- Function of the keys and the display of the S-control panel.
- Run-up and slow-down time, max. speed of the rotor. Values see operating instructions chapter "Anhang/Appendix, Rotoren und Zubehör/Rotors and accessories".
- Sample temperature. Values see operating instructions chapter "Anhang/Appendix, Rotoren und Zubehör/Rotors and accessories".
- Imbalance switch-off. Values see repair instructions chapter "Imbalance switch-off".
- Current consumption. Values see repair instructions chapter "Technical specifications".

After the test run a safety test must be carried out. Check the following values:

- Insulation resistance > 2 M Ω
 - Protective conductor resistance < 0.2 Ω
 - Leakage current < 3.5 mA *
- * limit according to EN 61010

A laboratory centrifuge do not belong to those medical appliances which may be tested according to the regulation IEC 601 or corresponding national medical electronic standards. Laboratory centrifuges are classified as laboratory equipment.

The regulations applying to laboratory equipment are IEC 1010 or European standard EN 61010.

7 Mounting and removing components

7.1 Removing the front panel

- Open the lid.
- Switch off the mains switch and disconnect the centrifuge from the mains supply.
- Undo the screws on the lower part of the front panel.
4 screws in centrifuges with cooling, 3 screws in centrifuges without cooling.
- Press (push) the front panel upwards out of the guide rail.
- Remove the flat ribbon cable (A4/X1 or A5/X1) and the cable of the temperature sensor (A4/X100 or A5/X2) from the control panel.
- Turn the contact block board of the lid button by 45° and remove it, see Fig. 3 to Fig. 5.
- Remove the front panel.
- To mount the front panel, carry out these steps in opposite order.

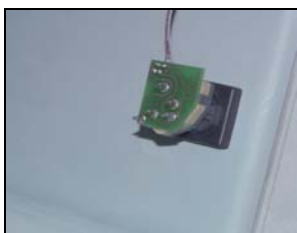

Fig. 3



Fig. 4



Fig. 5

7.2 Removing the support sheet of the electronic components

- Remove the front panel as described in chapter "Removing the front panel".
- Undo the screws on the left, right and top of the support sheet (two screws each).
- Loosen the screws (Fig. 6, b) on the lower part of the support sheet by approx. 5 mm.
- Lift the support sheet and push it horizontally into the cut-out (Fig. 10, a) located in the left side of the centrifuge housing, see Fig. 7 and Fig. 10.
If the support sheet is provided with round cut-outs (Fig. 8, a), lift the support sheet and suspend it horizontally on the screws, see Fig. 7 and Fig. 8.
If only rectangular cut-outs (Fig. 6, a) exist, lift the support sheet and place it horizontally on the two holders (Fig. 9, a) provided for this purpose, see Fig. 7 and Fig. 9.
- To mount the support sheet, carry out these steps in opposite order.

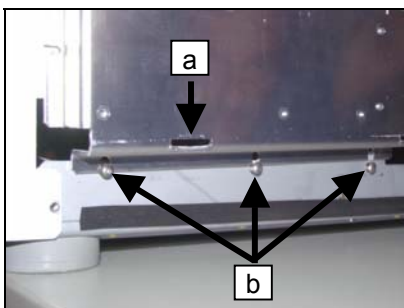

Fig. 6



Fig. 7

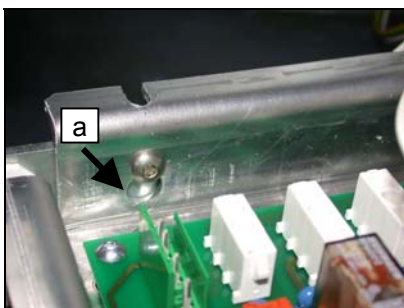

Fig. 8

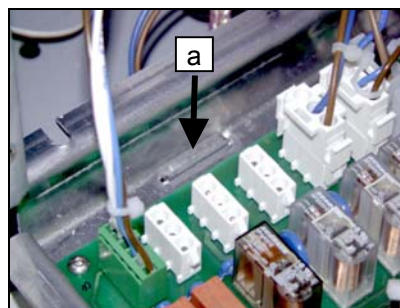

Fig. 9

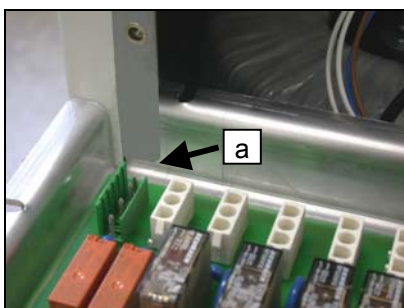

Fig. 10

7.3 Removing the upper part of the centrifuge housing

- Remove the front panel as described in chapter "Removing the front panel".
- Remove the support sheet for electronic components as described in chapter "Removing the support sheet of the electronic components".

- Pull the lid lock plug X10 on the supply board (A1), see chapter "Connecting diagrams".
- Pull the protective conductor connection on the lid lock.
- Undo the fastening screws of the upper part of the centrifuge housing.
4 screws each on the left and right side of the upper part of the housing, 6 screws on its rear. In centrifuges with cooling, undo the two screws on the front of the upper part of the centrifuge housing.
- Remove the upper part of the centrifuge housing and place it next to the centrifuge.
- To mount the upper part of the housing, carry out these steps in opposite order.

7.4 Motor (M1)

- Remove the front panel as described in chapter "Removing the front panel".
- Remove the support sheet for electronic components as described in chapter "Removing the support sheet of the electronic components".
- Pull the X2 and X4 plugs on the frequency converter (A2), see in chapter "Connecting diagrams".
- Dismount the rotor.
- Undo the four screws on the motor cover and remove the motor cover.
- In centrifuges with cooling, remove the rubber packing between the motor cover and the centrifuge chamber.
- Undo the screws of the speed sensor to separate it from the upper end plate of the motor (two screws (Fig. 11, a)) and place it in the centrifuging chamber.
- Undo the screw (Fig. 11, b) of both laterally mounted vibration dampers. Take care that the screws do not fall into the motor area.
- Undo the three fastening screws (Fig. 11, c) on the lower end plate of the motor.
- Take out the motor from the centrifuge from above.
- Before mounting the motor, check the rubber-metal bearings on the motor supporting ring for possible wear or cracks and both lateral vibration dampers for proper functioning and replace them if necessary, see chapters "Rubber-metal bearings" and "Vibration dampers".
- To mount the motor, carry out these steps in opposite order.
- After exchanging the motor the imbalance cutoff must be checked, see chapter "Imbalance switch-off".

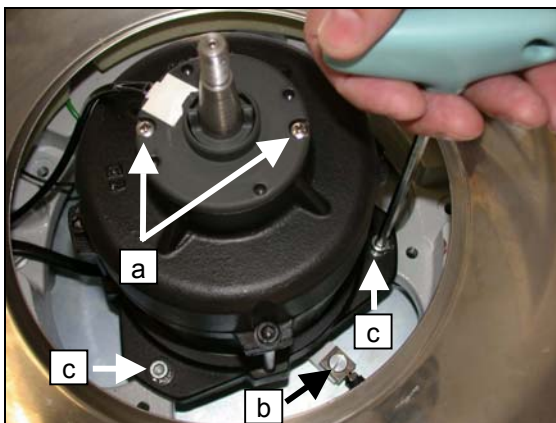

Fig. 11

7.5 Rubber-metal bearings

- Dismount the motor as described in chapter "Motor (M1)".
- Undo the fastening screws (Fig. 12, a) of the rubber-metal bearings on the motor supporting ring.
- Centrifuge with serial no. XXXX-00-XX: 5 rubber-metal bearings.
Centrifuge from serial no. XXXX-01-XX: 3 rubber-metal bearings.
- Push the motor supporting ring (Fig. 12, b) to the side. Remove one rubber-metal bearing after the other and replace them.
- To mount the rubber-metal bearings, carry out these steps in opposite order. While mounting the rubber-metal bearings, make sure that there is an anti-twist device (Fig. 13, a) on both sides of the bearing to prevent it from turning.
- After exchanging the rubber-metal bearings the imbalance cutoff must be checked, see chapter "Imbalance switch-off".

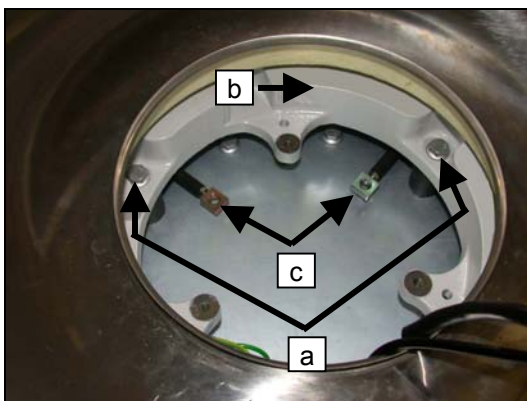

Fig. 12

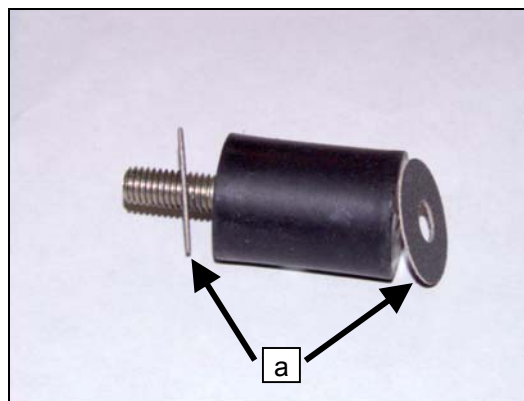

Fig. 13

7.6 Vibration dampers

- Dismount the motor as described in chapter "Motor (M1)".
- Place something under the centrifuge so that you can access the screws of the vibration dampers (Fig. 12, c) under the centrifuge.
- Undo the two fastening screws of each vibration damper on the outer part of the housing floor.
- Remove the vibration dampers (Fig. 12, c).
- To mount the vibration dampers, carry out these steps in opposite order.

7.7 Speed sensor

- Remove the front panel as described in chapter "Removing the front panel".
- Remove the support sheet for electronic components as described in chapter "Removing the support sheet of the electronic components".
- Pull the X5 plug on the supply board (A1), see chapter "Connecting diagrams".
- Remove all fixing elements (Fig. 14, a) of the speed sensor cable.
- Undo the screws to separate the speed sensor from the upper end plate of the motor (two screws (Fig. 11, a)) and remove it.
- To mount the speed sensor, carry out these steps in opposite order. Fasten the speed sensor cable again, see Fig. 14.

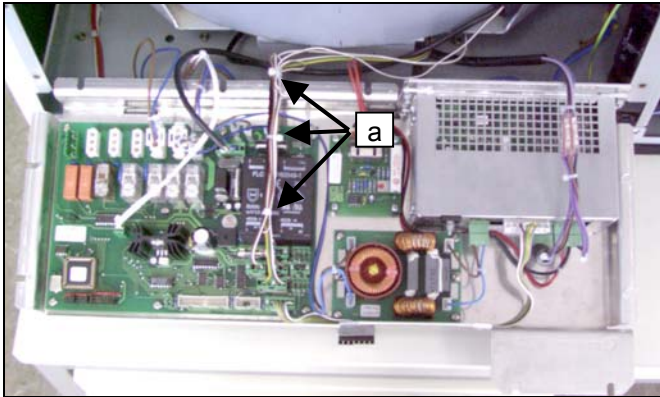

Fig. 14

7.8 Motor-driven lid lock

All plastic parts on the motor-driven lid lock are wearing parts and must be replaced if they are worn out.

7.8.1 Removing the motor-driven lid lock

- Remove the front panel as described in chapter "Removing the front panel".
- Remove the support sheet for electronic components as described in chapter "Removing the support sheet of the electronic components".
- Pull the lid lock plug X10 on the supply board (A1), see chapter "Connecting diagrams".
- Remove the protective conductor connection (Fig. 15, a) on the lid lock.
- Undo the two screws (Fig. 15, b) each of the left and right lid lock on the upper part of the centrifuge housing and remove the lid lock.
- To mount the motor-driven lid lock, carry out these steps in opposite order.

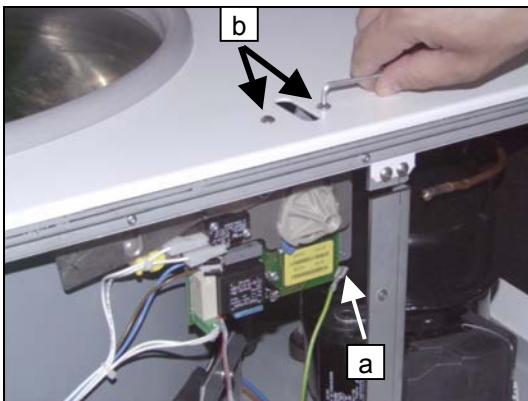

Fig. 15

7.8.2 Replacing the motor-lock unit

- Dismount the lid lock as described in chapter "Removing the motor-driven lid lock".
- Use the hexagon pin driver to turn the eccentric disc (Fig. 16, a) until the hexagon socket points upwards.
- Undo the hexagon socket screw (Fig. 16, b).
- Lift the connecting rod (Fig. 17, b) and pull it out of the eccentric disc (Fig. 16, a), see Fig. 17.
- Pull the plug (Fig. 17, c) on the motor-lock unit (Fig. 17, A8). Then press both black lock clips (Fig. 16, c) on the terminal strip upwards and pull out both cables.
- To mount the motor-lock unit, carry out these steps in opposite order.

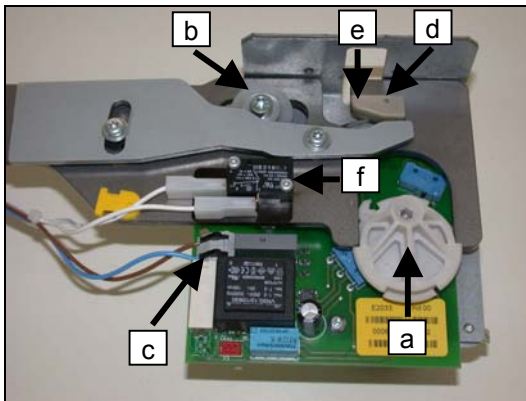

Fig. 16

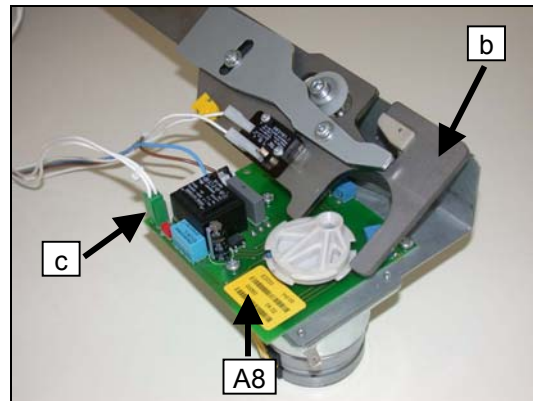

Fig. 17

7.8.3 Replacing the angle support on the left

- Dismount the lid lock as described in chapter "Removing the motor-driven lid lock".
- Suspend the tension spring (Fig. 18, a) on one side.
- Undo the hexagon socket screw (Fig. 18, b).
- Exchange the angle support (Fig. 18, c).
- To mount the support, carry out these steps in opposite order.

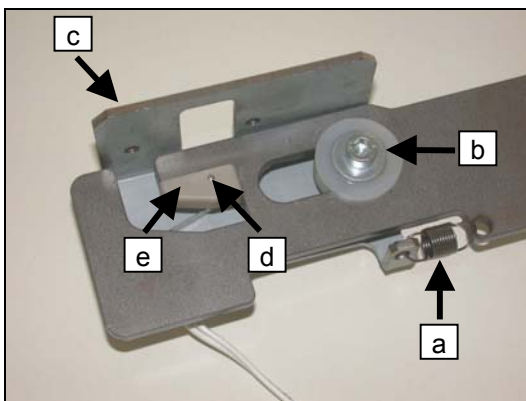

Fig. 18

7.8.4 Replacing the eccentric disc

- Dismount the motor-lock unit as described in chapter "Replacing the motor-lock unit".
- Undo the hexagon socket screw (Fig. 19, a) on the eccentric disc.
- Remove the eccentric disc from the motor axis.
- Push the new eccentric disc as far as it will go on the motor axis and tighten the hexagon socket screw (Fig. 19, a) on the eccentric disc.
- Assemble in opposite order.

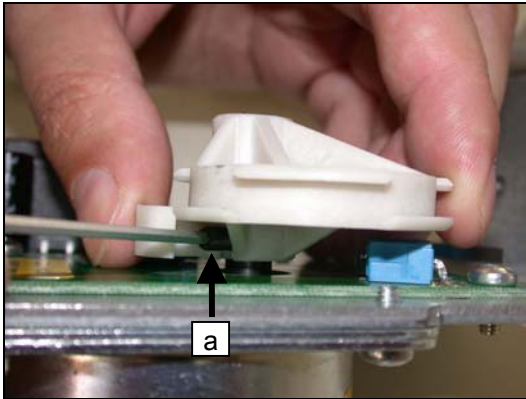

Fig. 19

7.8.5 Replacing the sliding blocks

- Dismount the lid lock as described in chapter "Removing the motor-driven lid lock".
- Push out the steel pin (Fig. 16, Fig. 18, d) from the sliding block (Fig. 16, Fig. 18, e) with a piercer.
- Remove the sliding block (Fig. 16, Fig. 18, e).
- Mount the new sliding block (Fig. 16, Fig. 18, e).
- Drive the steel pin (Fig. 16, Fig. 18, d) into the borehole of the sliding block (Fig. 16, Fig. 18, e) with a hammer.

7.8.6 Replacing the plastic rollers and discs

- Dismount the lid lock as described in chapter "Removing the motor-driven lid lock".

On the motor-lock unit:

- Use the hexagon pin driver to turn the eccentric disc (Fig. 16, a) until the hexagon socket points upwards.
- Undo the hexagon socket screw (Fig. 16, b).
- Replace the plastic roller and both plastic discs.
- Assemble in opposite order.

On the left angle support:

- Undo the hexagon socket screw (Fig. 18, b).
- Replace the plastic roller and both plastic discs.
- Assemble in opposite order.

7.8.7 Replacing the microswitch

- Close the lid.
- Switch off the mains switch.
- Pull out both cables from the microswitch (Fig. 16, f).
- Undo both fastening screws of the microswitch.
- Replace the microswitch (Fig. 16, f).
- Assemble in opposite order.

7.9 Control panel (A4, A5)

- Remove the front panel as described in chapter "Removing the front panel".

7.9.1 N-control panel (A4)

- Undo the two fastening screws of both angle brackets.
- Take the N-control panel out of the front panel from the front.
- To mount the N-control panel, carry out these steps in opposite order.

7.9.2 S-control panel (A5)

- Undo the four screws on the housing cover of the S-control panel.
- Remove the housing cover.
- Take the S-control panel out of the front panel from the front.
- To mount the S-control panel, carry out these steps in opposite order.

7.10 EPROM in the control panel

- Remove the front panel as described in chapter "Removing the front panel".
- In the S-control panel, press one side of the cover spring of the EPROM cover with a finger and, at the same time, pull the spring out of its holder on this side with a screwdriver. Remove the cover spring and the EPROM cover.
- Before touching the EPROM, make sure that you have discharged the electrostatic charge in your body (e.g. by touching a radiator).
- Carefully take out the EPROM from the IC holder.
- Carefully press the new EPROM into the IC holder. Make sure that its installation position is correct. The notch of the IC holder must lie on top of the notch of the EPROM housing. The notch of the IC holder and the notch of the EPROM housing must be on the same side. The IC pins may not be bent.
- Place the EPROM cover on the S-control panel and hang the cover spring on one side. Press down the opposite side of the cover spring until it locks into place,

7.11 Battery (only in S-control panel)

- Remove the front panel as described in chapter "Removing the front panel".
- Undo the four screws of the housing cover of the S-control panel.
- Remove the housing cover.
- Take the S-control panel out of the front panel from the front.
- Unsolder and open contact 1 on the DIP switch (DIP switch see chapter "Initializing the centrifuge with S-control panel").
Now the capacitors on the S-control panel will supply voltage to the RAM for approx. 40 minutes. After that, the saved data will be lost.

- Undo the fastening screws of the control panel board and lift the board carefully, see Fig. 20.
- Unsolder the battery.
- Solder the new battery.
Pay attention to the polarity of the battery, see Fig. 20.
- To mount the S-control panel, carry out these steps in opposite order.

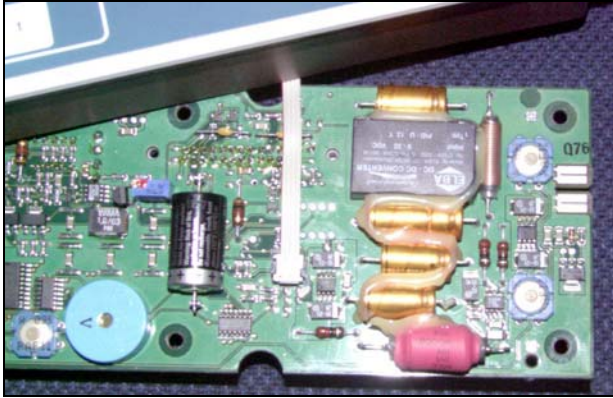

Fig. 20

7.12 Supply board (A1)

- Remove the front panel as described in chapter "Removing the front panel".
- Remove the support sheet for electronic components as described in chapter "Removing the support sheet of the electronic components".
- Pull out all plugs on the supply board.
- Undo the seven fastening screws of the supply board.
- Remove the supply board.
- To mount the supply board, carry out these steps in opposite order.
For plug positions, refer to chapter "Connecting diagrams".

7.13 Frequency converter (A2)

- Remove the front panel as described in chapter "Removing the front panel".
- Remove the support sheet for electronic components as described in chapter "Removing the support sheet of the electronic components".
- Pull out all plugs on the frequency converter.
- Undo the four fastening screws of the frequency converter.
- Remove the frequency converter.
- To mount the frequency converter, carry out these steps in opposite order.
Before mounting it, make sure that there is sufficient heat conduction paste between the support sheet and the frequency converter housing. If necessary, scrape off the heat conduction paste from the housing of the old frequency converter and apply it on the new frequency converter housing. For plug positions, refer to chapter "Connecting diagrams".

7.14 Braking chopper (A3)

- Remove the front panel as described in chapter "Removing the front panel".
- Remove the support sheet for electronic components as described in chapter "Removing the support sheet of the electronic components".
- Undo the screws on the terminal strip and pull out all four cables.
- Undo the four fastening screws of the braking chopper.
- Remove the braking chopper.
- To mount the braking chopper, carry out these steps in opposite order. For the position of the cables, see chapter "Connecting diagrams".

7.15 Radio interference suppression filter (Z1)

- Remove the front panel as described in chapter "Removing the front panel".
- Remove the support sheet for electronic components as described in chapter "Removing the support sheet of the electronic components".
- Pull out all plugs on the radio interference suppression filter.
- Undo the six fastening screws of the radio interference suppression filter.
- Remove the radio interference suppression filter.
- To mount the radio interference suppression filter, carry out these steps in opposite order. For the position of the cables, see chapter "Connecting diagrams".

7.16 Brake resistor (R1)

- Remove the front panel as described in chapter "Removing the front panel".
- Remove the support sheet for electronic components as described in chapter "Removing the support sheet of the electronic components".
- Remove the upper part of the housing as described in chapter "Removing the upper part of the centrifuge housing".
- Pull out the X28 plug on the supply board (A1), see in chapter "Connecting diagrams".
- Loosen the screws of terminals 2 and 3 on the terminal strip located on the braking chopper and pull out both cables of the brake resistor.
- Remove all cable fastening elements on the cables of the brake resistor.
- Undo both screws on the brake resistor and remove the brake resistor.
- To mount the brake resistor, carry out these steps in opposite order. Fasten the cables of the brake resistor again.

7.17 Temperature sensors (only in centrifuges with cooling)

- Remove the front panel as described in chapter "Removing the front panel".
- Remove the support sheet for electronic components as described in chapter "Removing the support sheet of the electronic components".

7.17.1 Temperature sensor at the top of the centrifuge chamber (T1)

- Dismount the lid lock as described in chapter "Motor-driven lid lock".
- Remove the sealing ring next to the temperature sensor from the centrifuging chamber.
- Pull out the temperature sensor from the rear.
- Remove the silicone sealing compound residue from the borehole.
- To mount the temperature sensor, carry out these steps in opposite order. Seal the temperature sensor with silicone sealing compound.
- After the installation an OFFSET compensation must be performed. See chapter "OFFSET compensation".

7.17.2 Temperature sensor at the bottom of the centrifuge chamber (T2)

- Pull out the X2 plug on the supply board (A1), see chapter "Connecting diagrams".
- Remove all cable fastening elements on the temperature sensor cable.
- Remove the plug of the temperature sensor.
- Pull out the temperature sensor from the centrifuge chamber.
- Pull the cable of the new temperature sensor through the borehole in the centrifuge chamber and press the temperature sensor into the borehole.
- Connect the plug supplied with the temperature sensor to the temperature sensor cable. For plug assignment, refer to chapter "Connecting diagrams".
- Plug the temperature sensor plug at plug position X2 on the supply board (A1), see chapter "Connecting diagrams".
- Fasten the cable of the temperature sensor.
- After the installation an OFFSET compensation must be performed. See chapter "OFFSET compensation".

7.17.3 Temperature sensor on the condenser (T3)

- Pull out the X1 plug on the supply board (A1), see chapter "Connecting diagrams".
- Remove all cable fastening elements on the temperature sensor cable.
- Remove the temperature sensor on the condenser.
- To mount the temperature sensor, carry out these steps in opposite order.
The temperature sensor must be mounted on the condenser at exactly the same position as earlier. Make sure that there is sufficient heat conduction paste between the cooling tube and the temperature sensor.
- After the installation an OFFSET compensation must be performed. See chapter "OFFSET compensation".

7.18 Imbalance switch (S2)

- Remove the front panel as described in chapter "Removing the front panel".
- Remove the support sheet for electronic components as described in chapter "Removing the support sheet of the electronic components".
- Pull the X6 plug on the supply board (A1), see chapter "Connecting diagrams".
- With centrifuges up to serial no. XXXX-01-XX, place something under the centrifuge so that you can access both screws at the angle bracket of the imbalance switch under the centrifuge. Undo both screws of the angle bracket on the outer part of the housing floor.
With centrifuges from serial no. XXXX-02-XX, undo both screws (Fig. 21, a) of the angle bracket.
- Take the angle bracket (Fig. 21, b) with the imbalance switch out of the centrifuge.
- Unscrew the imbalance switch (Fig. 21, c) from the angle bracket.
- To mount the imbalance switch, carry out these steps in opposite order.
After the installation the imbalance cutoff must be checked, see chapter "Imbalance switch-off".

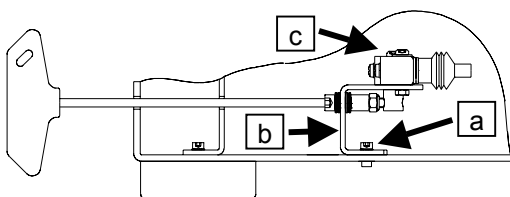

Fig. 21

7.19 Mains switch

- Remove the front panel as described in chapter "Removing the front panel".
- Remove the support sheet for electronic components as described in chapter "Removing the support sheet of the electronic components".
- Place the support sheet on the table in front of the centrifuge.
- Pull the plug on the mains switch.
- Press out the mains switch from the lower part of the centrifuge housing.
- To mount the mains switch, carry out these steps in opposite order.

7.20 Appliance plug with overvoltage protection

- Remove the front panel as described in chapter "Removing the front panel".
- Remove the support sheet for electronic components as described in chapter "Removing the support sheet of the electronic components".
- Remove the upper part of the centrifuge housing as described in chapter "Removing the upper part of the centrifuge housing".
- Remove the varistor board from the appliance plug.
- Undo the screws to separate the appliance plug from the lower part of the centrifuge housing.
- To mount the appliance plug and the varistor board, carry out these steps in opposite order.

7.21 Gas spring

The gas springs may be dismantled only if the lid is open, i.e. if the gas springs are not under tension.

- Remove the front panel as described in chapter "Removing the front panel".
- Remove the support sheet for electronic components as described in chapter "Removing the support sheet of the electronic components".
- Remove the upper part of the centrifuge housing as described in chapter "Removing the upper part of the centrifuge housing".
- Open the lid.
- Loosen the stop spring of the connecting pin of the fork head on the piston of the gas spring (in the upper part of the centrifuge housing).
- Press the opened lid slightly to the back in order to relieve the connecting pin. Take out the connecting pin.



Hold the lid with your hand as the force of one gas spring is not sufficient to keep the lid open.

- Remove the stop spring of the connecting pin of the fork head on the gas spring housing (on the lid) and take out the connecting pin.
- To mount the gas spring, carry out these steps in opposite order.

7.22 Sealing ring (between the upper part of the centrifuge housing and the lid)

- Open the lid.
- Switch off the mains switch and disconnect the centrifuge from the mains supply.
- Pull out the sealing ring from the gap between the centrifuging chamber and the upper part of the centrifuge housing. Take care that the temperature sensor at the top of the centrifuge chamber get not damaged.
- The diameter of the sealing ring is slightly larger than the cut-out in the upper part of the housing. Insert the sealing ring in such a way that the temperature sensor is in the notch provided for it in the sealing ring. Press the sealing ring into the gap while rubbing it with a piece of cloth.

7.23 Key-operated switch (A7; only in S-control panel)

- Remove the front panel as described in chapter "Removing the front panel".
- Remove the support sheet for electronic components as described in chapter "Removing the support sheet of the electronic components".
- Place the support sheet on the table in front of the centrifuge.
- The hole for the key-operated switch is located left of the mains switch. Insert the key-operated switch (Fig. 22, a) into the hole, so that the fastening projection (Fig. 22, b) is in the groove of the hole.
- Tightly screw up the key-operated switch (Fig. 22, a) using the nut (Fig. 22, c).
- Attach the board of the key-operated switch (Fig. 22, d) to the contact maker (Fig. 22, e).
- Attach both cable sockets to the flat plugs of the board of the key-operated switch (Fig. 22, d).
- In order to prevent the key-operated switch from damage, the contact maker (Fig. 22, e) may only be attached or detached, when the key-operated switch is in middle position (Fig. 22, f). Attach the contact maker (Fig. 22, e) to the key-operated switch (Fig. 22, a) so that both cable connections are on the same side as the fastening projection (Fig. 22, b) of the key-operated switch. See Fig. 22. In order to detach the contact maker (Fig. 22, e), turn it by 45° and remove it from the key-operated switch (Fig. 22, a).
- Plug the cable of the key-operated switch at plug position X27 on the supply board (A1). For plug position see chapter "Connecting diagrams".
- Attach the support sheet of the electronic components as described in chapter "Removing the support sheet of the electronic components".
- Saw out of the front panel the opening for the key-operated switch according to Fig. 23 and Fig. 24 and afterwards break the edges.
- Attach the front panel as described in the chapter "Removing the front panel".
- Function of the key-operated switch see chapter "Option: key-operated switch (only for S-control panel)".

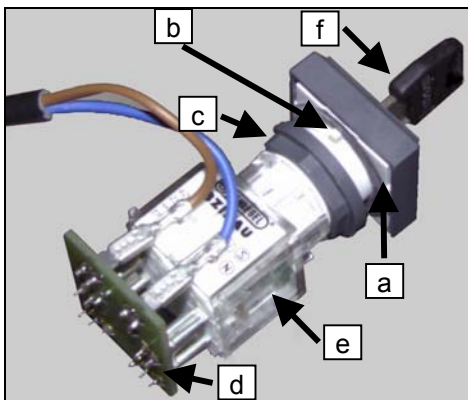

Fig. 22

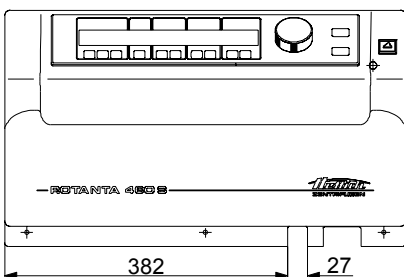

Fig. 23 ROTANTA 460 S

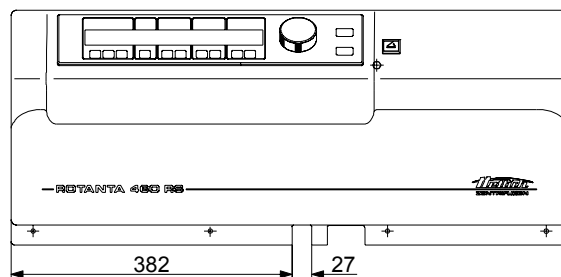

Fig. 24 ROTANTA 460 RS

7.24 Optical interface (A6; only in S-control panel)

- Remove the front panel as described in chapter "Removing the front panel".
- Undo the four screws of the housing cover of the S-control panel.
- Remove the housing cover.
- Take the S-control panel out of the front panel from the front.
- Unscrew the three connecting screws of the uncomponented part of the circuit board and cut the uncomponented part at the four links (Fig. 25, a) from the control panel circuit board.
- Plug the serial interface board (Fig. 26, A5.1) in the 20-pole connector (Fig. 26, b).
- Fix the serial interface board (Fig. 26, A5.1) with the three connecting screws.
- Put the S-control panel again into the front panel from the front and install its housing cover.
- Remove the support sheet for electronic components as described in chapter "Removing the support sheet of the electronic components".
- Remove on the back wall the holder plate (Fig. 27, a) for the optical interface board.
- Press out both plastic body-bound rivets (Fig. 27, b) from the holder plate and remove the plastic cover (Fig. 27, c).
- Install the optical interface board (Fig. 28, A6) on the holder plate. Fitting position of the board, see Fig. 28.
- Plug the flat ribbon cable (six-pole) on plug position X1 on the optical interface (Fig. 28, A6).
- Lay the flat ribbon cable along the holder on the opposite side of the brake resistor to the front of the centrifuge. To avoid damaging the flat ribbon cable because of too high temperature the cable may not contact the brake resistor.

- Plug a jumper on the coding strip of the supply board (A1) at position B.4.
- Attach the support sheet of the electronic components as described in chapter "Removing the support sheet of the electronic components".
- Plug the flat ribbon cable (six-pole) coming from the optical interface on plug position X4 on the serial interface board in the control panel, see in chapter "Connecting diagrams".
- Attach the front panel as described in chapter "Removing the front panel".

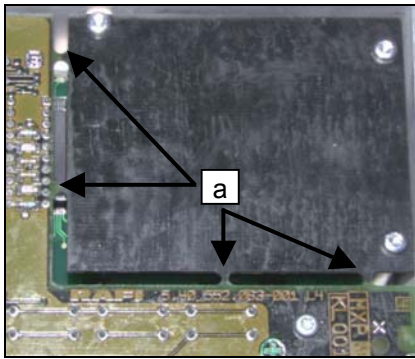

Fig. 25

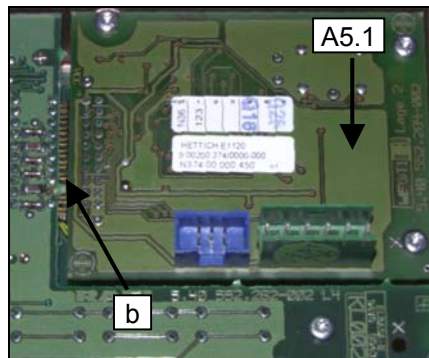

Fig. 26

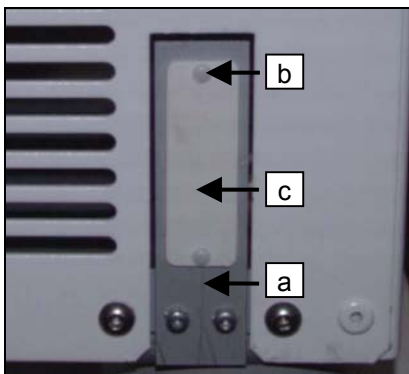

Fig. 27

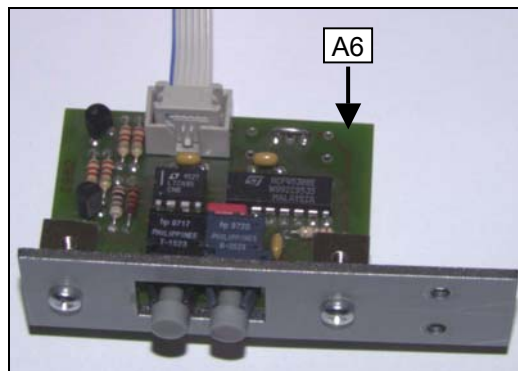
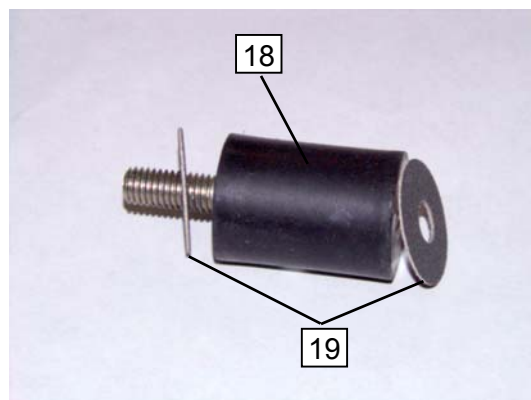
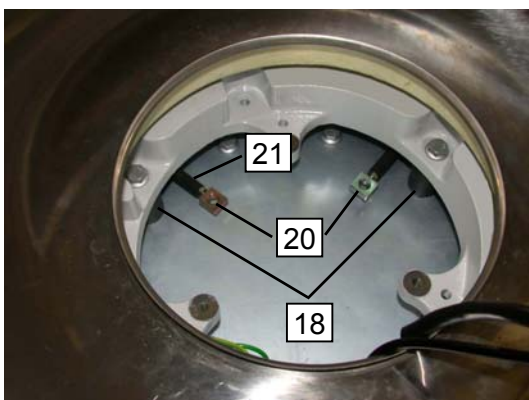
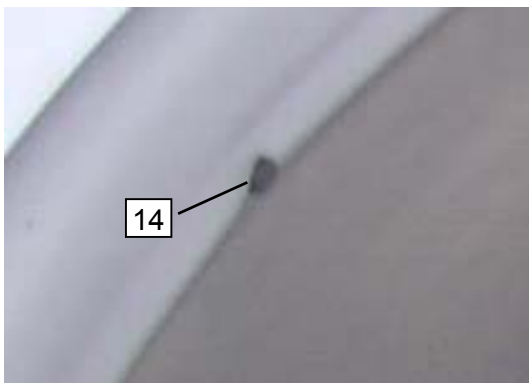
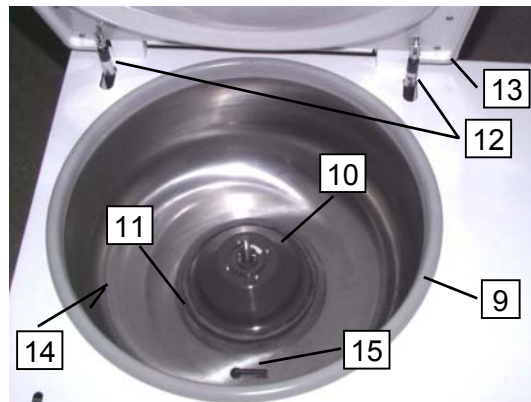
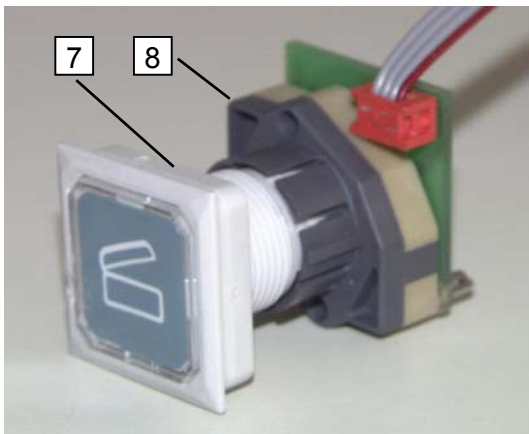
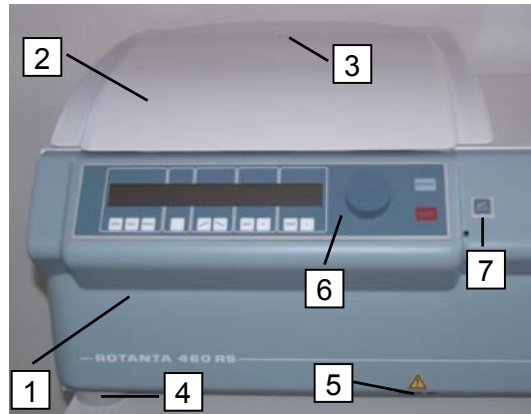
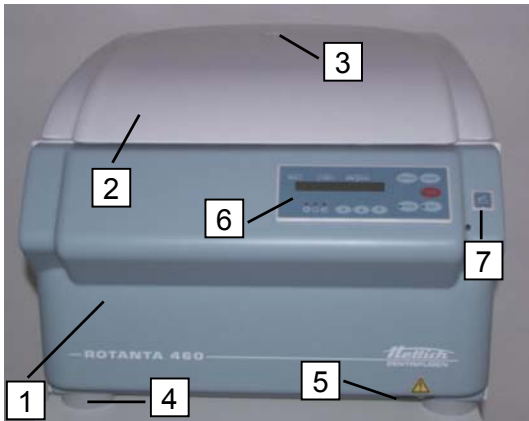
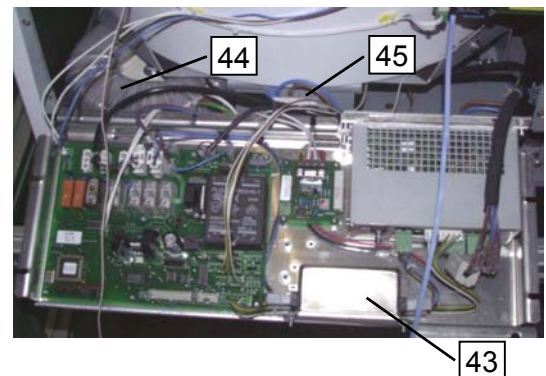
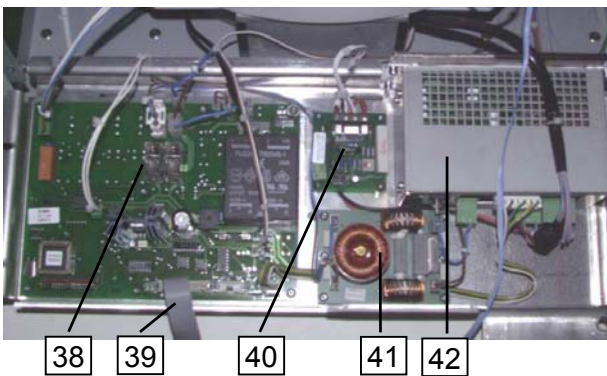
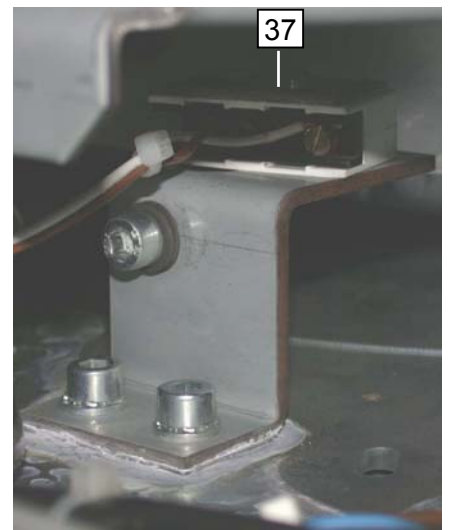
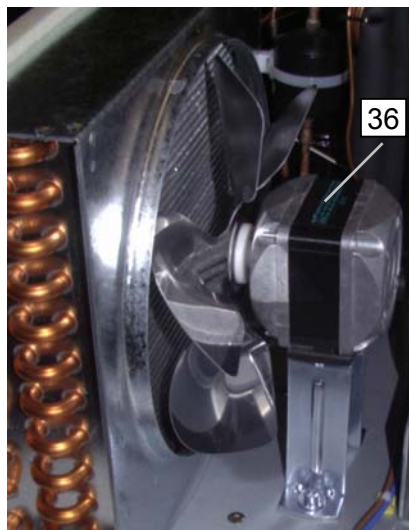
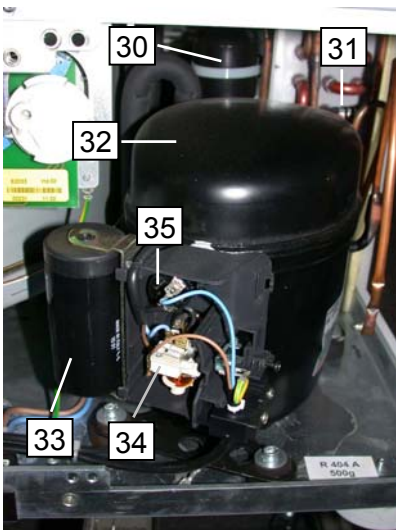
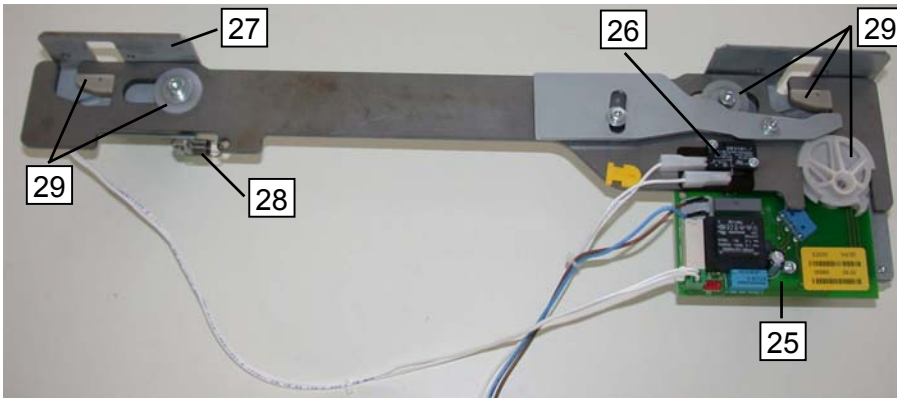
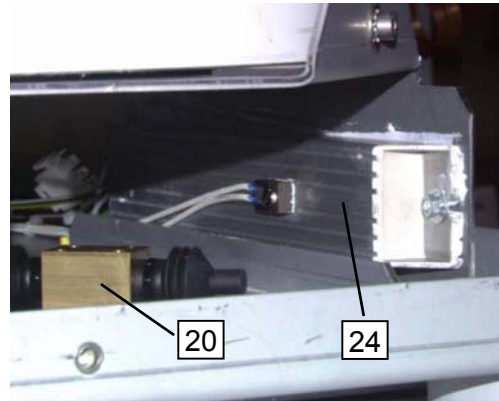
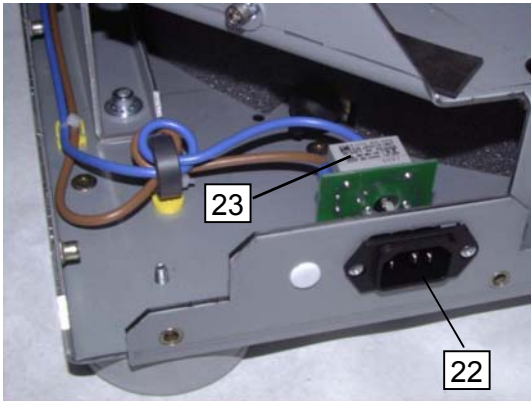

Fig. 28

8 Designation of the components

Item	Designation
1	Front panel
2	Lid complete
3	Sight-glass and gluing ring
4	Rubber foot
5	ON – OFF switch
6	Control panel
7	Lid open-button
8	Contact block board
9	Sealing ring (between the upper part of the centrifuge housing and the lid)
10	Motor cover
11	Folded bellow (between motor and centrifuge chamber)
12	Pneumatic spring without fork joint
13	Profiled joint with gluing film
14	Temperature sensor (at the top of the centrifuge chamber)
15	Temperature sensor (at the bottom of the centrifuge chamber)
16	Motor
17	Speed sensor (tacho)
18	Rubber-metal bearing
19	Anti-twist device
20	Damper with bracket
21	Rubber-metal bearing (at damper)
22	Appliance plug
23	Varistor board
24	Brake resistor with overtemperature switch
25	Motor-lock unit
26	Microswitch (at motor driven lid lock)
27	Left angle support
28	Tension spring
29	Wearing parts motor driven lid lock
30	dryer
31	Temperature sensor (at the condenser)
32	compressor
33	Starting capacitor
34	Starting relay
35	Protective Motor switch
36	Fan motor
37	Microswitch (Imbalance)
38	Supply board
39	Flat ribbon cable
40	Braking chopper
41	Radio interference suppression filter (230 V version)
42	Frequency converter
43	Radio interference suppression filter (115 V version)
44	Transformer (only with 115 V version)
45	Strip terminal (only with 115 V version)





9 Technical documents

9.1 Tachometer code configuration of the rotors

Example: tachometer code no. 1

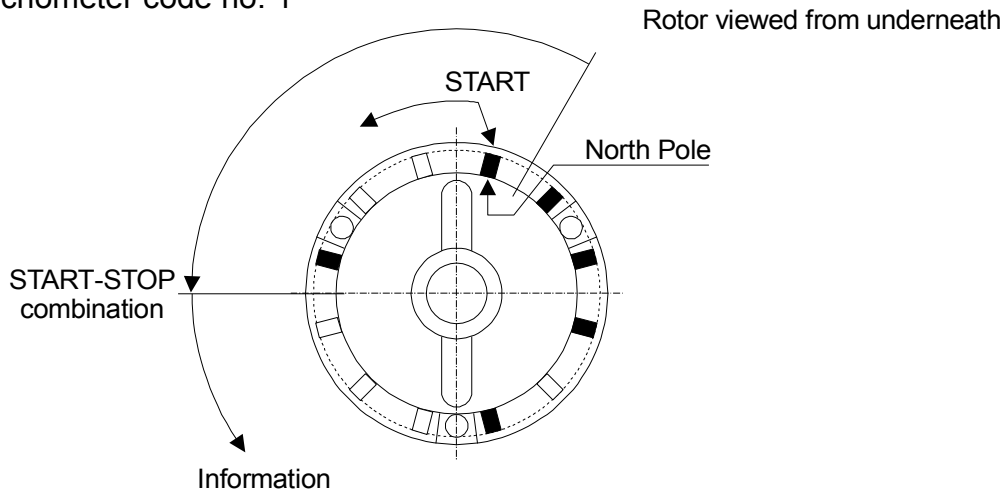

tachometer code determines: 1. maximum speed of rotor
2. run up and braking ramps
3. control response of electronics

e.g. Rotor 4446

1001,00010111



rotor code

Start / Stop combination.

The begin of the Start / Stop combination is marked with a white dot.

0 = no magnet (empty place), 1 = magnet inserted

9.1.1 Centrifuge without cooling

Tachometer code-no.:	Configuration	RPM	Rotor
0	1001 00001111		
1	1001 00010111	4000	4446 / 4474
2	1001 00011011	4500	4444
3	1001 00011101	6000	4445
4	1001 00011110	6000	4450/4448
5	1001 01000111	5900	4620
6	1001 01010101	15000	4489
7	1001 01010110	4600	5624
8	1001 01011010		
9	1001 01100011	11500	5615
10	1001 01110001	8500	5645
11	1001 10000111		
12	1001 10001011	2000	5616
13	1001 10001101		
14	1001 10100011		
15	1001 11000011		

9.1.2 Centrifuge with cooling

Tachometer code-no.:	Configuration	RPM	Rotor
0	1001 00001111		
1	1001 00010111	4000	4446 / 4474
2	1001 00011011	4500	4444
3	1001 00011101	7500	4445
4	1001 00011110	7500	4450 / 4448
5	1001 01000111	6200	4620
6	1001 01010101	15000	4489
7	1001 01010110	4600	5624
8	1001 01011010		
9	1001 01100011	11500	5615
10	1001 01110001	9500	5645
11	1001 10000111		
12	1001 10001011	2000	5616
13	1001 10001101		
14	1001 10100011		
15	1001 11000011		

9.2 Cooling diagram

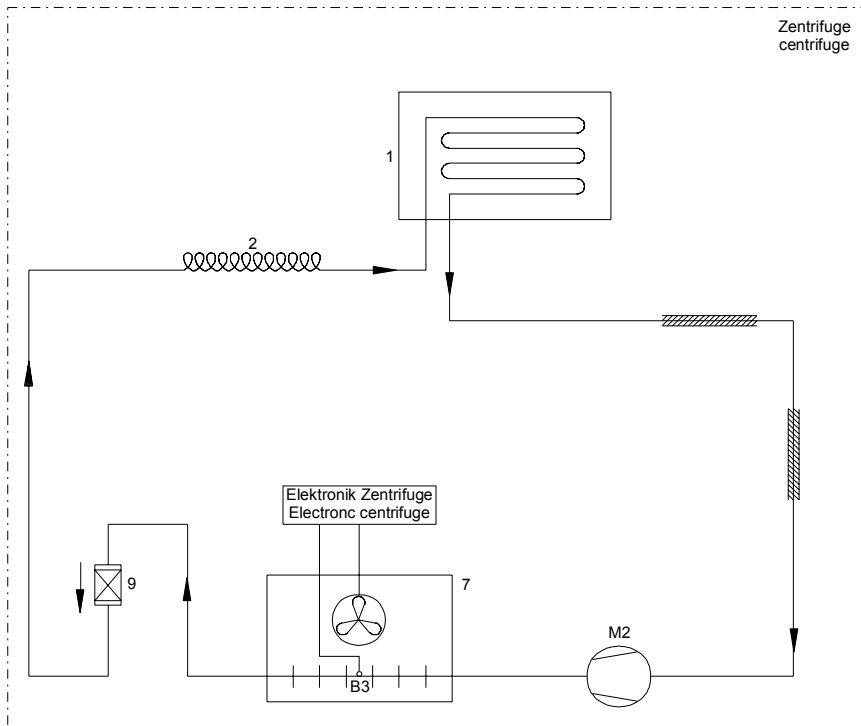

1	Evaporator (centrifuge chamber)
2	Capillary tube
7	Air-cooled condenser
9	Filter dryer (flow direction vertical from top to bottom !!!)
B3	Temperature sensor on condenser (controlled by centrifuge electronics)
M2	Compressor

9.3 Connecting diagrams

9.3.1 Abbreviations of the cable colours

Abbreviation	Colour
BK	black
BN	brown
BU	blue
GD	gold
GN	green
GNYE	green-yellow
GY	grey
OG	orange
PK	pink
RD	red
SR	silver
TQ	turquoise
Transp.	transparent
VT	violet
WH	white
YE	yellow

9.3.2 Connecting diagram centrifuge

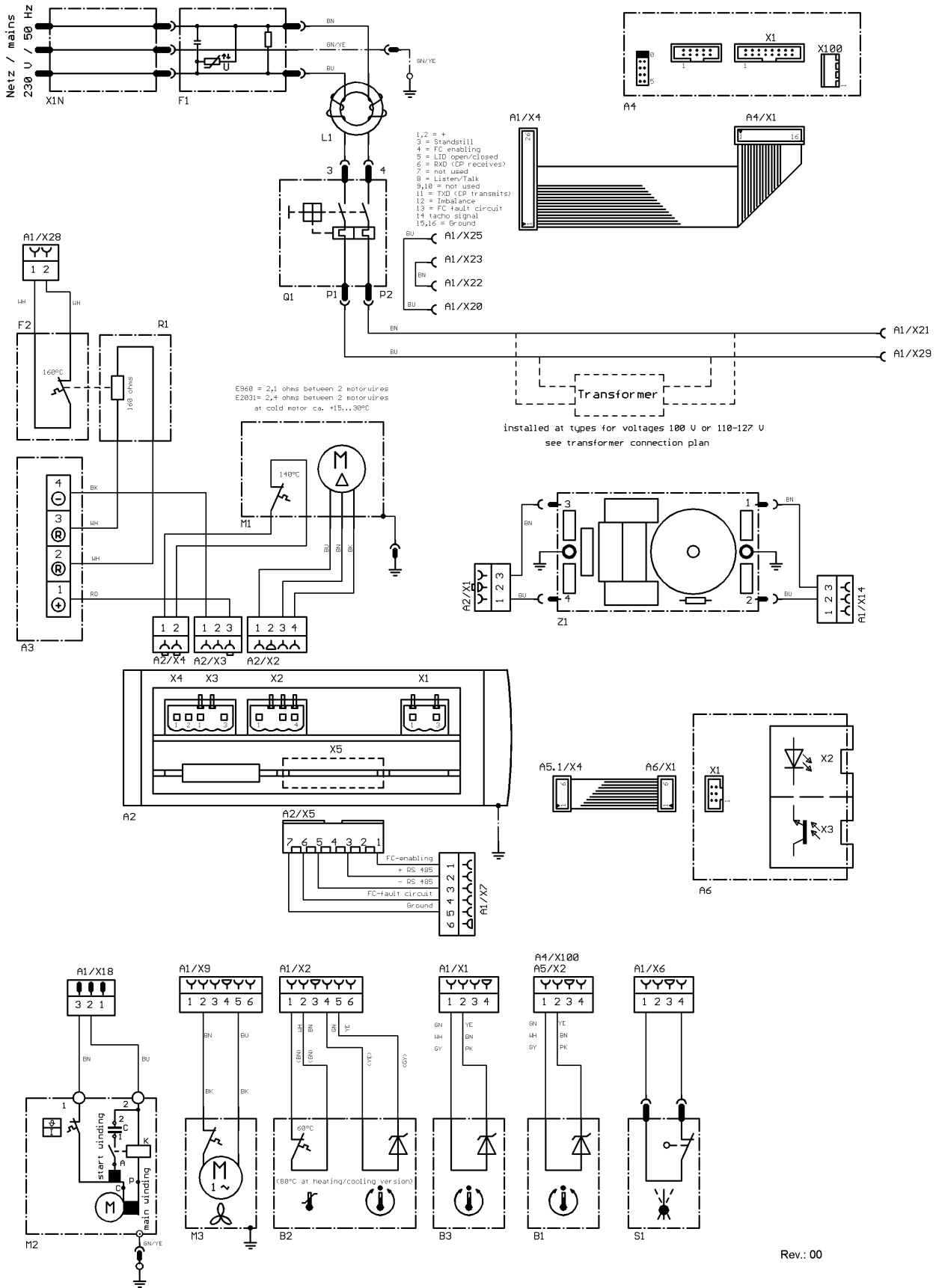

Rev.: 00

60 Hz type C-Rz 11,0 ohms C-R: 3 ohms

9.3.3 Transformer connection

9.3.3.1 Centrifuge without cooling system

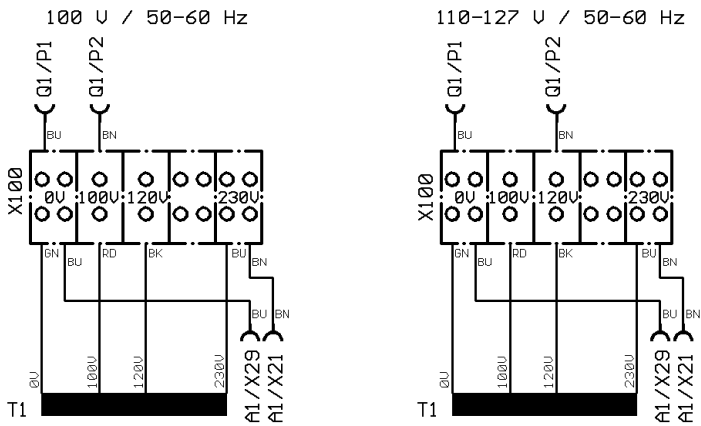

Rev.: 00

9.3.3.2 Centrifuge with cooling system

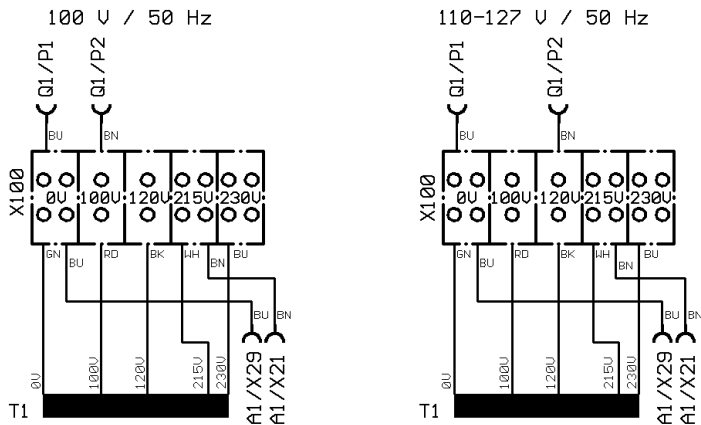
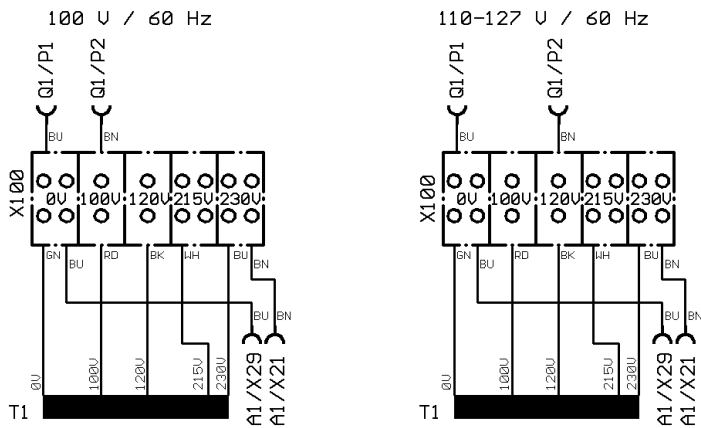

Rev.: 00

9.4 Technical specifications

Hersteller / Manufacturer[blo1]	Hettich Zentrifugen D-78532 Tuttlingen	
Typenbezeichnung / Model	ROTANTA 460	
Verkaufs-Nr. / Product no.	5600	5600-01
Netzspannung / Mains voltage ($\pm 10\%$)	208-240 V 1~	110-127 V 1~
Netzfrequenz / Mains frequency	50 - 60 Hz	50 - 60 Hz
Anschlusswert / Connected load	1500 VA	1300 VA
Stromaufnahme / Current consumption	6.5 A	11 A
Kältemittel / Refrigerant	----	
Kapazität max. / Max. capacity	4 x 750 ml	
zulässige Dichte / Max. density	1.2 kg/dm ³	
Drehzahl / Speed RPM	15000	
Beschlg. / Force RCF	24400	
Kinetische Energie / Kinetic energy	41000 Nm	
Prüfpflicht / Obligatory inspection	ja / yes	
Umgebungsbedingungen (EN 61010-1)/ Ambient conditions (EN 61010-1)	<p>nur in Innenräumen / Indoors only bis zu 2000 m über Normal-Null / Up to 2000 m above sea level 2°C bis 40°C / 2°C up to 40°C</p> <p>maximale relative Luftfeuchte 80% für Temperaturen bis 31°C, linear abnehmend bis 50% relativer Luftfeuchte bei 40°C. / Maximum relative humidity 80% for temperatures up to 31°C, linearly decreasing to 50% relative humidity at 40°C.</p>	
– Aufstellungsort / Set-up site		
– Höhe / Altitude		
– Umgebungstemperatur / Ambient temperature		
– Luftfeuchtigkeit / Humidity		
– Verschmutzungsgrad / Degree of contamination	2	
Geräteschutzklasse / Class of protection	I	
nicht für den Einsatz in explosionsgefährdeter Umgebung geeignet. / Not suitable for use in explosion-endangered areas.		
EMV / EMC		
– Störaussendung (Funkentstörung) / Emission (Radio interference suppression)	EN 55011 Gruppe 1, Klasse B / Group 1, Class B EN 61000-3-3	FCC Class A
– Störfestigkeit / Immunity	EN 61000-6-1	----
Geräuschpegel (rotorabhängig) / Noise level (dependent on rotor)	≤ 70 dB(A)	
Abmessungen / Dimensions		
• Breite / Width	554 mm	
• Tiefe / Depth	707 mm	
• Höhe / Height	453 mm	
Gewicht ca. / Weight approx.	106 kg	115 kg

Hersteller / Manufacturer	Hettich Zentrifugen D-78532 Tuttlingen		
Typenbezeichnung / Model	ROTANTA 460 R		
Verkaufs-Nr. / Product no.	5605, 5605-20 5605-50	5605-07	5605-01, 5605-51
Netzspannung / Mains voltage ($\pm 10\%$)	208-240 V 1~	208-240 V 1~	110-127 V 1~
Netzfrequenz / Mains frequency	50 - 60 Hz	60 Hz	60 Hz
Anschlusswert / Connected load	2400 VA	2200 VA	2000 VA
Stromaufnahme / Current consumption	10 A	10 A	16 A
Kältemittel / Refrigerant	R 404A		
Kapazität max. / Max. capacity	4 x 750 ml		
zulässige Dichte / Max. density	1.2 kg/dm ³		
Drehzahl / Speed RPM	15000		
Beschlg. / Force RCF	24400		
Kinetische Energie / Kinetic energy	51000 Nm		
Prüfpflicht / Obligatory inspection	ja / yes		
Umgebungsbedingungen (EN 61010-1)/ Ambient conditions (EN 61010-1)	<p>nur in Innenräumen / Indoors only</p> <p>bis zu 2000 m über Normal-Null / Up to 2000 m above sea level</p> <p>5°C bis 35°C / 5°C up to 35°C</p> <p>maximale relative Luftfeuchte 80% für Temperaturen bis 31°C, linear abnehmend bis 50% relativer Luftfeuchte bei 40°C. / Maximum relative humidity 80% for temperatures up to 31°C, linearly decreasing to 50% relative humidity at 40°C.</p>		
– Aufstellungsort / Set-up site			
– Höhe / Altitude			
– Umgebungstemperatur / Ambient temperature			
– Luftfeuchtigkeit / Humidity			
– Verschmutzungsgrad / Degree of contamination	2		
Geräteschutzklasse / Class of protection	I		
nicht für den Einsatz in explosionsgefährdeter Umgebung geeignet. / Not suitable for use in explosion-endangered areas.			
EMV / EMC	EN 55011 Gruppe 1, Klasse B / Group 1, Class B EN 61000-3-3		FCC Class A
– Störaussendung (Funkentstörung) / Emission (Radio interference suppression)			
– Störfestigkeit / Immunity	EN 61000-6-1		----
Geräuschpegel (rotorabhängig) / Noise level (dependent on rotor)	≤ 70 dB(A)		
Abmessungen / Dimensions			
• Breite / Width	770 mm		
• Tiefe / Depth	707 mm		
• Höhe / Height	453 mm		
Gewicht ca. / Weight approx.	147 kg		156 kg

Hersteller / Manufacturer[blo2]	Hettich Zentrifugen D-78532 Tuttlingen	
Typenbezeichnung / Model	ROTANTA 460 S	
Verkaufs-Nr. / Product no.	5601	5601-01
Netzspannung / Mains voltage ($\pm 10\%$)	208-240 V 1~	110-127 V 1~
Netzfrequenz / Mains frequency	50 - 60 Hz	50 - 60 Hz
Anschlusswert / Connected load	1500 VA	1300 VA
Stromaufnahme / Current consumption	6.5 A	11 A
Kältemittel / Refrigerant	----	
Kapazität max. / Max. capacity	4 x 750 ml	
zulässige Dichte / Max. density	1.2 kg/dm ³	
Drehzahl / Speed RPM	15000	
Beschlg. / Force RCF	24400	
Kinetische Energie / Kinetic energy	41000 Nm	
Prüfpflicht / Obligatory inspection	ja / yes	
Umgebungsbedingungen (EN 61010-1)/ Ambient conditions (EN 61010-1)	<p>nur in Innenräumen / Indoors only bis zu 2000 m über Normal-Null / Up to 2000 m above sea level 2°C bis 40°C / 2°C up to 40°C</p> <p>maximale relative Luftfeuchte 80% für Temperaturen bis 31°C, linear abnehmend bis 50% relativer Luftfeuchte bei 40°C. / Maximum relative humidity 80% for temperatures up to 31°C, linearly decreasing to 50% relative humidity at 40°C.</p>	
– Aufstellungsort / Set-up site		
– Höhe / Altitude		
– Umgebungstemperatur / Ambient temperature		
– Luftfeuchtigkeit / Humidity		
– Verschmutzungsgrad / Degree of contamination	2	
Geräteschutzklasse / Class of protection	I	
nicht für den Einsatz in explosionsgefährdeter Umgebung geeignet. / Not suitable for use in explosion-endangered areas.		
EMV / EMC		
– Störaussendung (Funkentstörung) / Emission (Radio interference suppression)	EN 55011 Gruppe 1, Klasse B / Group 1, Class B EN 61000-3-3	FCC Class A
– Störfestigkeit / Immunity	EN 61000-6-1	----
Geräuschpegel (rotorabhängig) / Noise level (dependent on rotor)	≤ 70 dB(A)	
Abmessungen / Dimensions		
• Breite / Width	554 mm	
• Tiefe / Depth	707 mm	
• Höhe / Height	453 mm	
Gewicht ca. / Weight approx.	106 kg	115 kg

Hersteller / Manufacturer	Hettich Zentrifugen D-78532 Tuttlingen		
Typenbezeichnung / Model	ROTANTA 460 RS		
Verkaufs-Nr. / Product no.	5606, 5606-20 5606-50	5606-07	5606-01, 5606-51
Netzspannung / Mains voltage ($\pm 10\%$)	208-240 V 1~	208-240 V 1~	110-127 V 1~
Netzfrequenz / Mains frequency	50 - 60 Hz	60 Hz	60 Hz
Anschlusswert / Connected load	2400 VA	2200 VA	2000 VA
Stromaufnahme / Current consumption	10 A	10 A	16 A
Kältemittel / Refrigerant	R 404A		
Kapazität max. / Max. capacity	4 x 750 ml		
zulässige Dichte / Max. density	1.2 kg/dm ³		
Drehzahl / Speed RPM	15000		
Beschlg. / Force RCF	24400		
Kinetische Energie / Kinetic energy	51000 Nm		
Prüfpflicht / Obligatory inspection	ja / yes		
Umgebungsbedingungen (EN 61010-1)/ Ambient conditions (EN 61010-1)	<p>nur in Innenräumen / Indoors only</p> <p>bis zu 2000 m über Normal-Null / Up to 2000 m above sea level</p> <p>5°C bis 35°C / 5°C up to 35°C</p> <p>maximale relative Luftfeuchte 80% für Temperaturen bis 31°C, linear abnehmend bis 50% relativer Luftfeuchte bei 40°C. / Maximum relative humidity 80% for temperatures up to 31°C, linearly decreasing to 50% relative humidity at 40°C.</p>		
– Aufstellungsort / Set-up site			
– Höhe / Altitude			
– Umgebungstemperatur / Ambient temperature			
– Luftfeuchtigkeit / Humidity			
– Verschmutzungsgrad / Degree of contamination	2		
Geräteschutzklasse / Class of protection	I		
nicht für den Einsatz in explosionsgefährdeter Umgebung geeignet. / Not suitable for use in explosion-endangered areas.			
EMV / EMC	EN 55011 Gruppe 1, Klasse B / Group 1, Class B EN 61000-3-3		FCC Class A
– Störaussendung (Funkentstörung) / Emission (Radio interference suppression)			
– Störfestigkeit / Immunity	EN 61000-6-1		----
Geräuschpegel (rotorabhängig) / Noise level (dependent on rotor)	≤ 70 dB(A)		
Abmessungen / Dimensions			
• Breite / Width	770 mm		
• Tiefe / Depth	707 mm		
• Höhe / Height	453 mm		
Gewicht ca. / Weight approx.	147 kg		156 kg